



floors
@work

PROJECT
FLOORS



Mehr zum Dekor!
More about the design!





Mehr zum Dekor!
More about the design!



PW 3130/FP

Planken / Planks	06
Designverlegungen / Design installations	128
Fischgrät / Herringbone	130
Chevron	136
Übersicht Planken / Overview planks	140
Fliesen / Tiles	146
Übersicht Fliesen / Overview tiles	202
Wissenswertes / Good to know	204
Die Vorteile von Designbodenbelägen The advantages of design floor coverings	206
Designbodenbeläge ohne Phthalatweichmacher Design floor coverings with non-phthalate plasticizer	208
Umweltschutz und Nachhaltigkeit, Raumklima Environment and sustainability, Indoor air climate	209
CO ₂ Kompensation / CO ₂ compensation	210
Zubehör / Accessoires	212
Fugenprofile und Design-Fugenprofile Feature strips and design strips	214
Sockelleisten / Skirting boards	216
Intarsien / Inlays	218
Technische Informationen / Technical Information	222
Verlegearten / Installation options	224
Technische Daten, Verlegung, Reinigung und Pflege Technical Data, installation, cleaning and Care	226
Fiche Technique, Instructions de pose, Instructions de nettoyage et d'entretien	234
Technische Gegevens, Legadvies, Reinigings- en onderhoudshandleiding	238
Ficha Técnica, Instrucciones de colocación, Instrucciones de limpieza y mantenimiento	242
Scheda Tecnica, Istruzioni di posa, Istruzioni di cura e pulizia	246

Planken Planks

PW 1245 /-55	68	PW 3058 /-55	88	PW 3261 /-55	20
PW 1246 /-55	44	PW 3065 /-55	90	PW 3262 /-55	16
PW 1250 /-55	60	PW 3066 /-55	82	PW 3350 /-55	70
PW 1255 /-55	26	PW 3070 /-55	08	PW 3361 /-55	92
PW 1260 /-55	38	PW 3079 /-55	28	PW 3535 /-55	120
PW 1261 /-55	112	PW 3100 /-55	46	PW 3610 /-55	106
PW 1265 /-55	54	PW 3110 /-55	48	PW 3620 /-55	126
PW 1270 /-55	24	PW 3115 /-55	104	PW 3810 /-55	42
PW 1275 /-55	32	PW 3130 /-55	116	PW 3811 /-55	122
PW 1380 /-55	34	PW 3140 /-55	52	PW 3820 /-55	102
PW 1633 /-55	66	PW 3150 /-55	74	PW 3840 /-55	94
PW 1634 /-55	96	PW 3160 /-55	72	PW 3841 /-55	86
PW 1905 /-55	98	PW 3190 /-55	80	PW 3860 /-55	18
PW 2002 /-55	100	PW 3200 /-55	12	PW 3880 /-55	10
PW 2003 /-55	114	PW 3210 /-55	14	PW 3881 /-55	110
PW 2020 /-55	76	PW 3220 /-55	64	PW 3900 /-55	22
PW 2400 /-55	118	PW 3230 /-55	62	PW 3910 /-55	50
PW 2980 /-55	40	PW 3240 /-55	58	PW 3911 /-55	124
PW 3020 /-55	56	PW 3241 /-55	84	PW 3912 /-55	30
PW 3021 /-55	36	PW 3260 /-55	108	PW 3913 /-55	78

/55

0,55 mm Nutzschrift
0.55 mm wear layer
2,5 mm Gesamtdicke
2.5 mm total thickness

SYNC

Diese Dekore haben eine
Synchronprägung.

These designs have a
registered emboss.



Stark kontrastierendes Design.

Strongly contrastive design.



Diese Dekore werden mit
angefaster Kante geliefert.

These designs will be
delivered with bevelled edges.



Diese Dekore sind auch in den
beiden Formaten 457 x 76 x 2,5 mm
und 610 x 102 x 2,5 mm mit 0,55 mm
Nutzschrift für eine Verlegung z.B.
im Fischgrät-Design verfügbar.

These designs are also available in
the two formats 457 x 76 x 2.5 mm
and 610 x 102 x 2.5 mm with
0.55 mm wear layer, for example
for a herringbone installation.



Diese Dekore sind auch im Format
457 x 102 x 2,5 mm im
Chevron-Schnitt mit 0,55 mm
Nutzschrift verfügbar.

These designs are also available
in 457 x 102 x 2.5 mm
as Chevron-Cut with 0.55 mm
wear layer.



Dekorpassende Sockelleiste
erhältlich.

Design fitting skirting board
available.



Diese Dekore sind auch als
LOOSE-LAY Variante mit 0,55 mm
Nutzschrift erhältlich.

These designs are also
available as LOOSE-LAY with
0.55 mm wear layer.



Bitte beachten Sie, dass die
Abbildung der Prägung einen stark
vergrößerten Ausschnitt darstellt
und das Gesamtbild auf der Planke
von Charge zu Charge abweichen
kann.

Please note that the image of the
embossing represents a greatly
enlarged section and the overall
image on the plank may vary from
batch to batch.



Mehr zum Dekor!
More about the design!

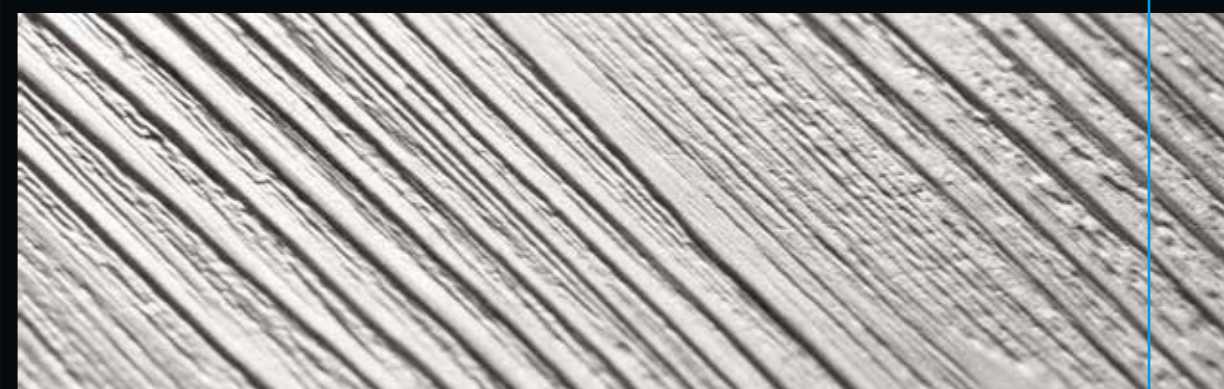
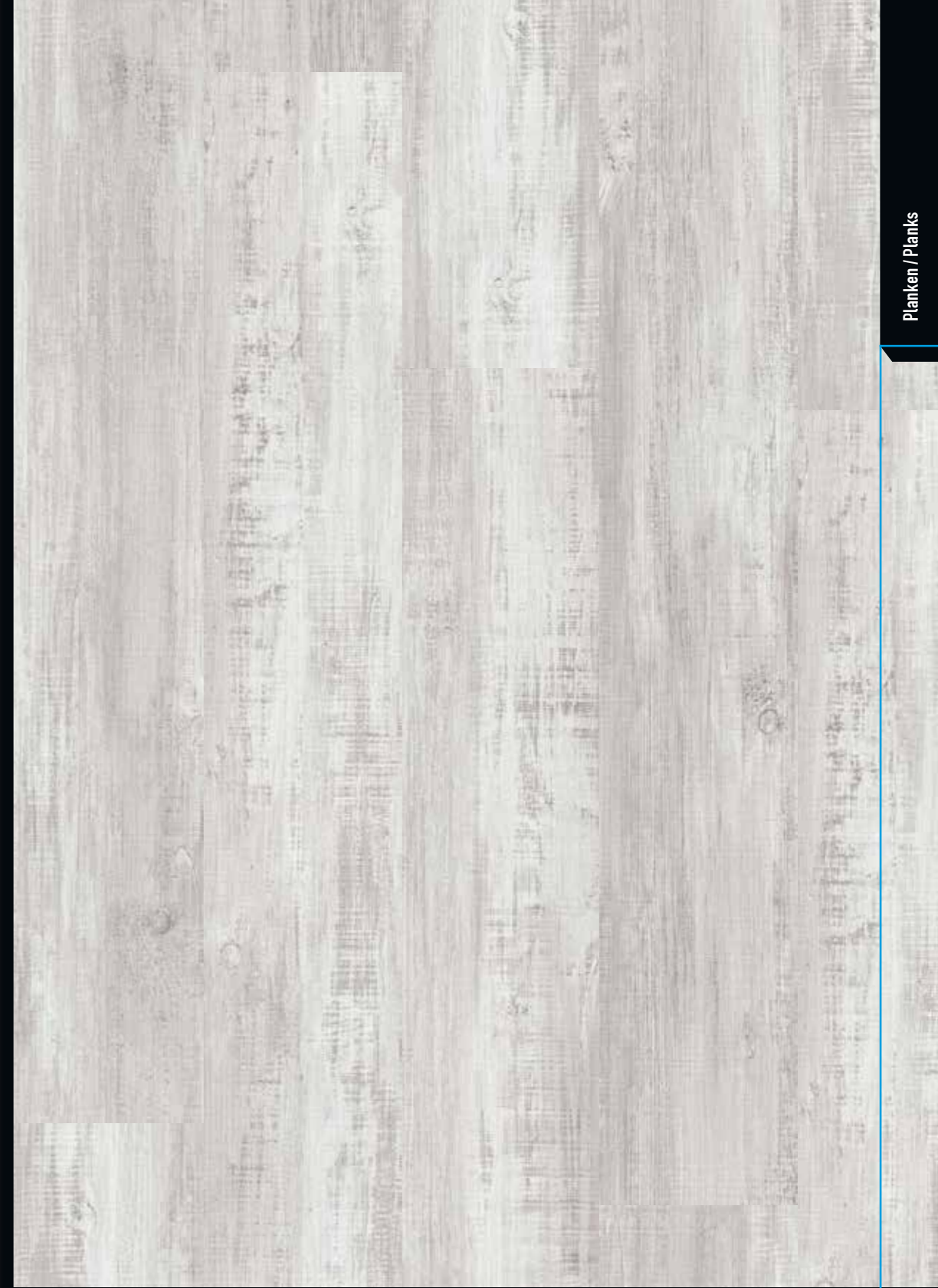

PW 3070 -/55



1219 x 183 x 2,5 mm



Mehr zum Dekor!
More about the design!

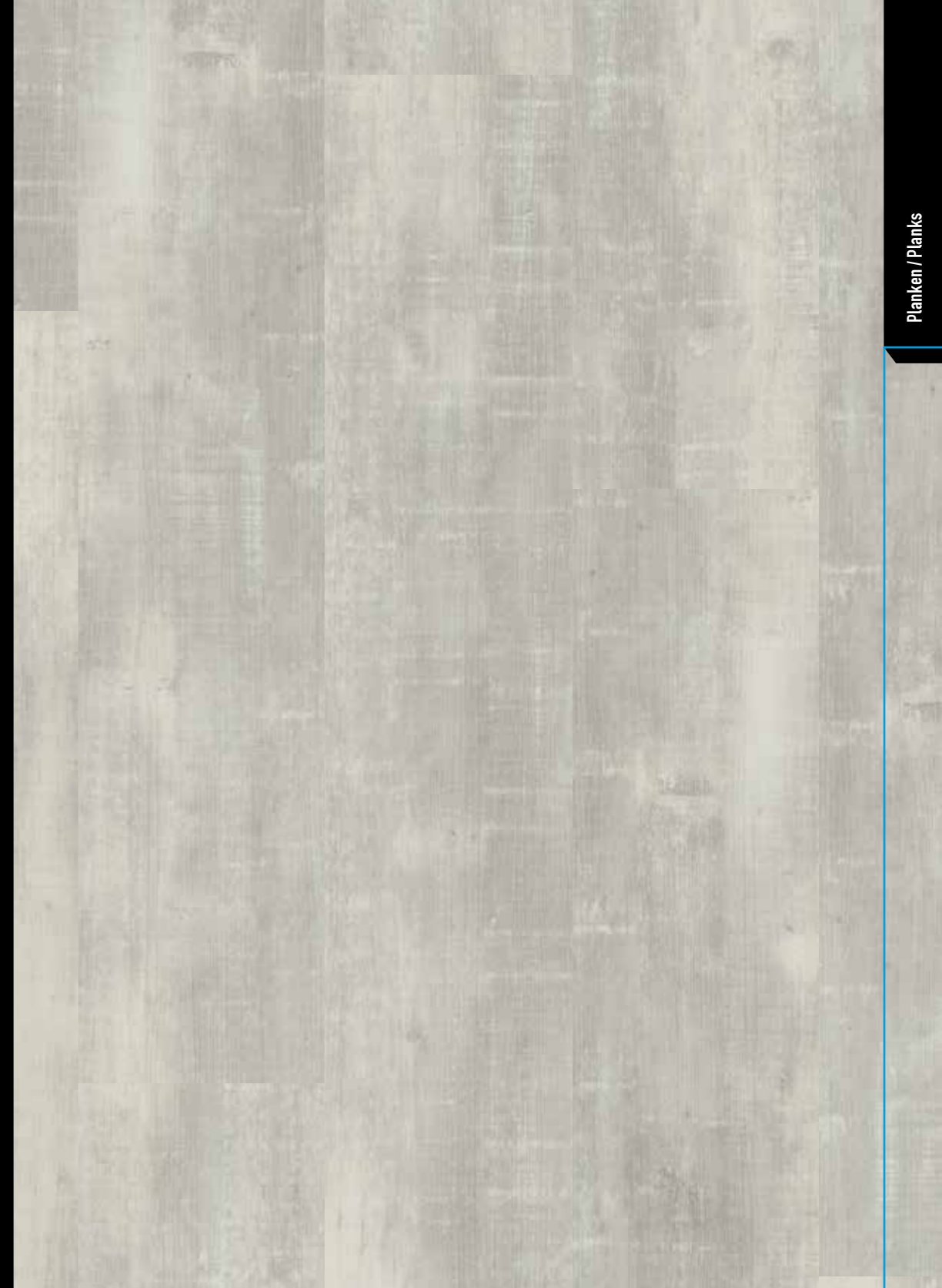

PW 3880 -/55



1219 x 228 x 2,5 mm



Mehr zum Dekor!
More about the design!

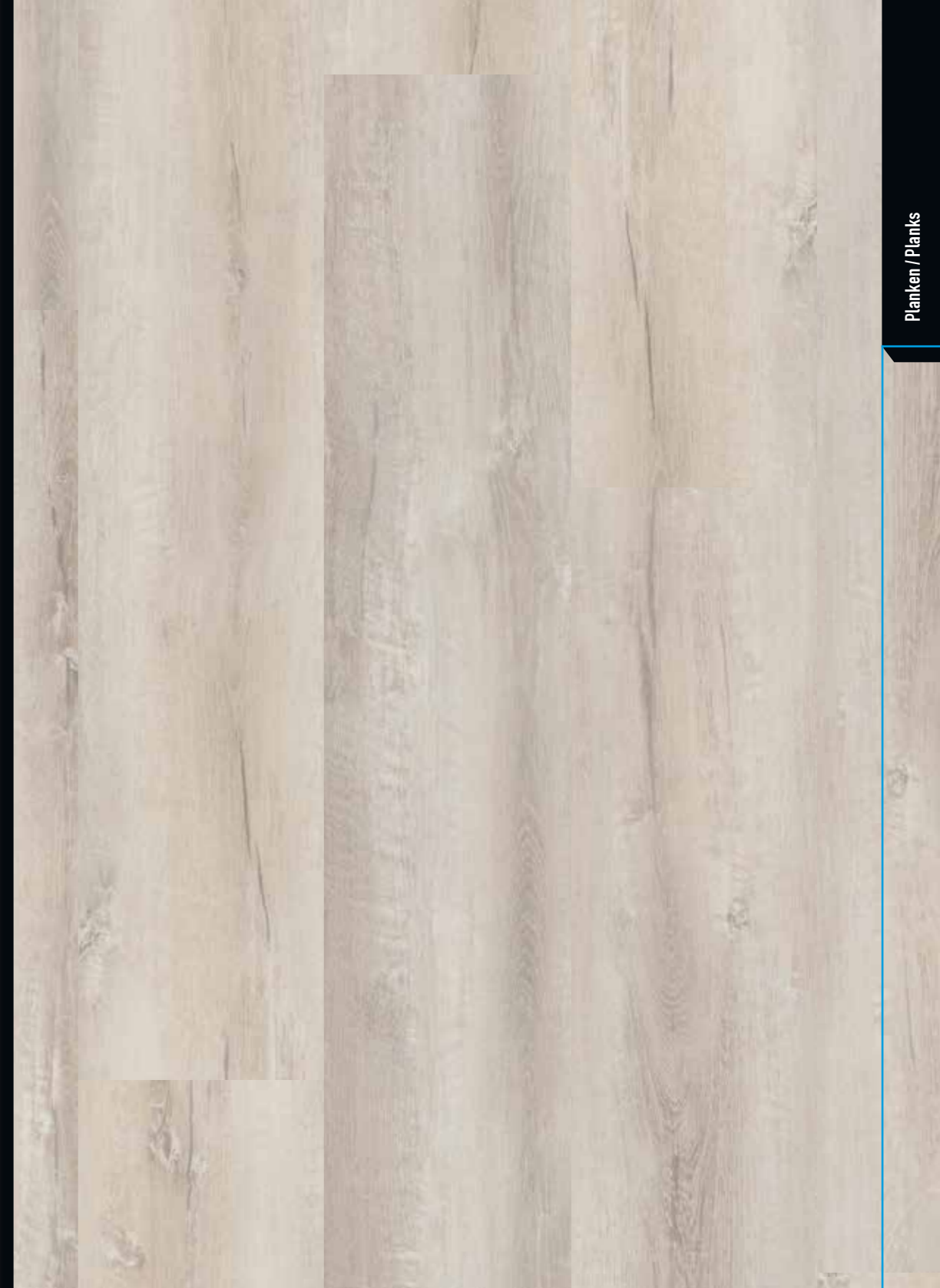

PW 3200 -/55



1219 x 228 x 2,5 mm



Mehr zum Dekor!
More about the design!

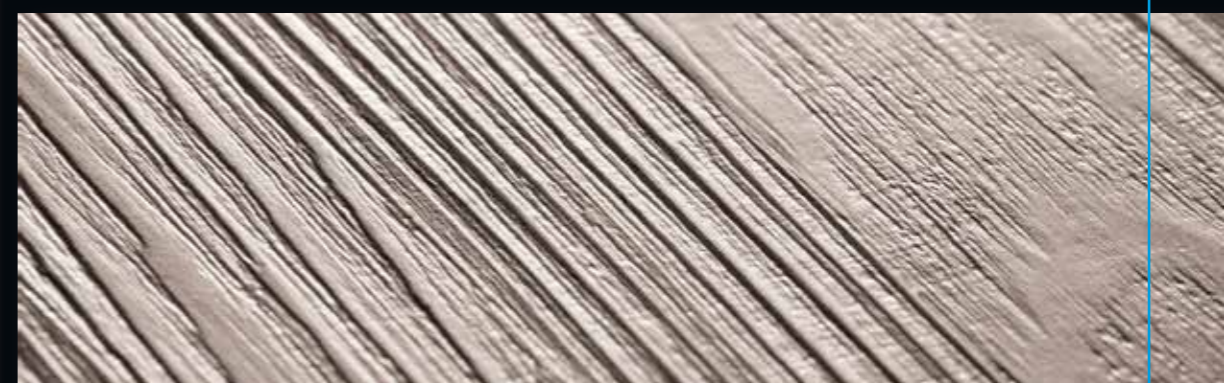

PW 3210 -/55

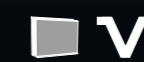

1219 x 228 x 2,5 mm



Mehr zum Dekor!
More about the design!

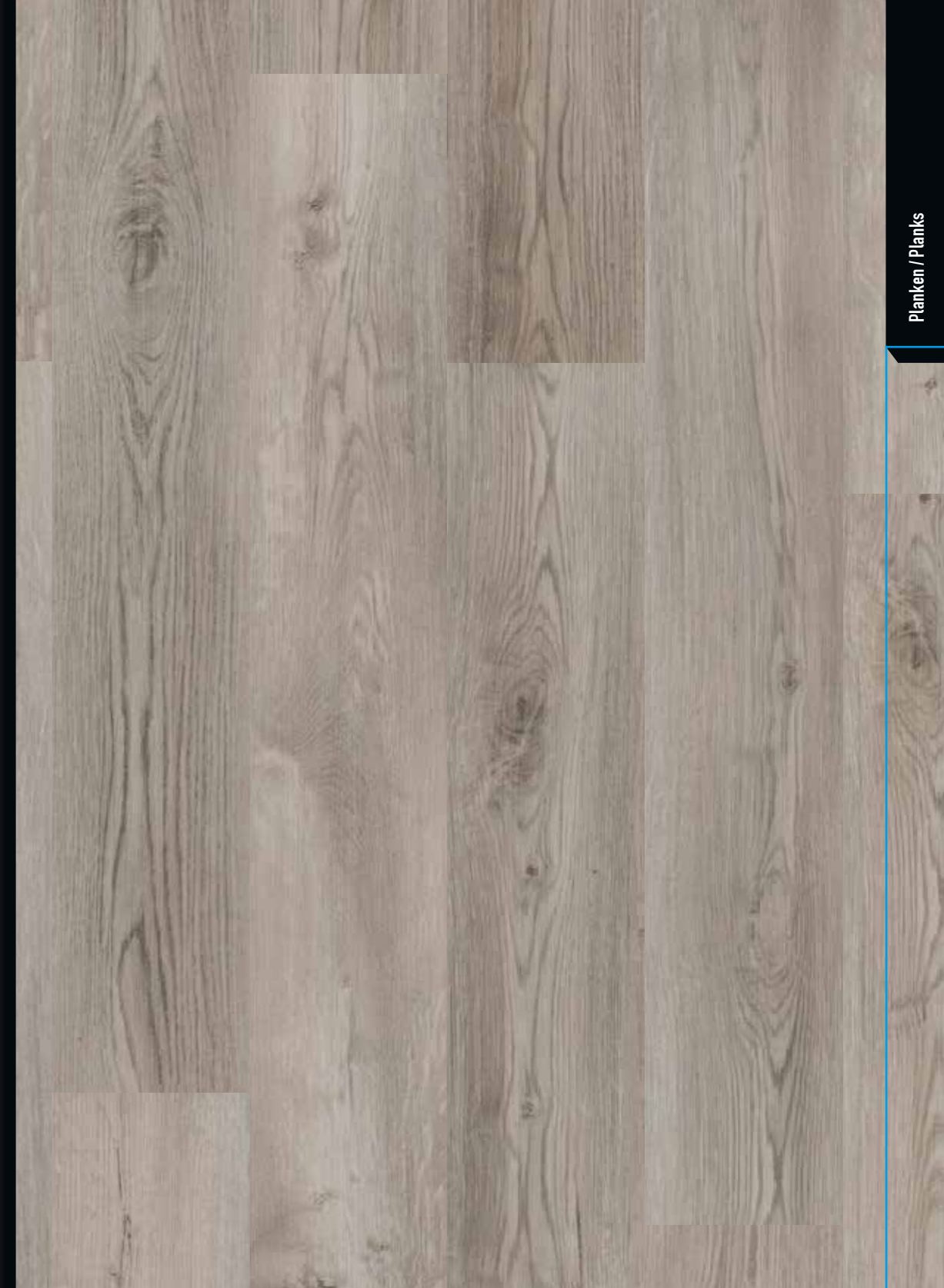

Planken / Planks



PW 3262 -/55



1219 x 183 x 2,5 mm



Mehr zum Dekor!
More about the design!

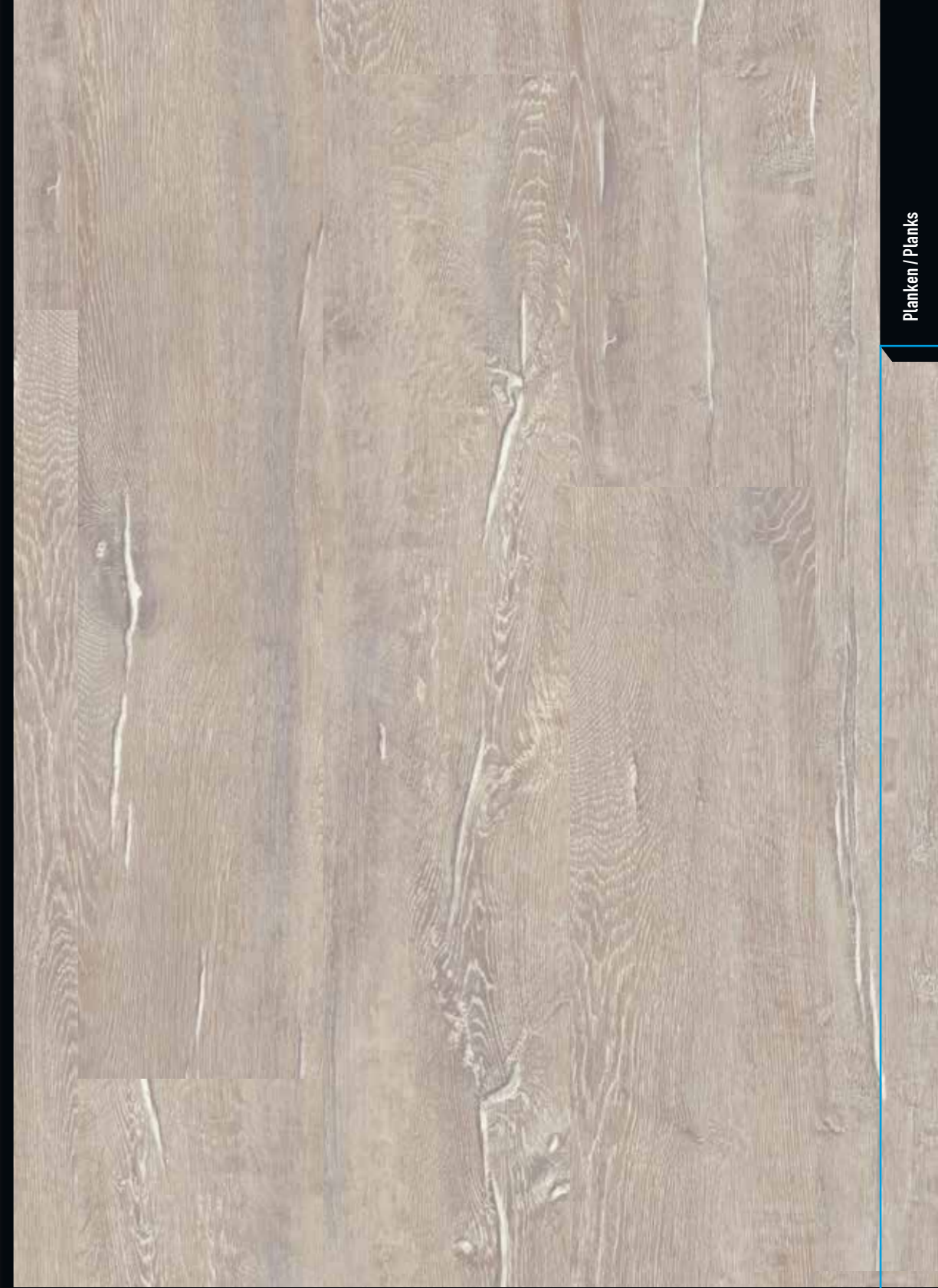

PW 3860 -/55

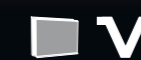

1219 x 228 x 2,5 mm



Mehr zum Dekor!
More about the design!

HOLGER BÖHRICH

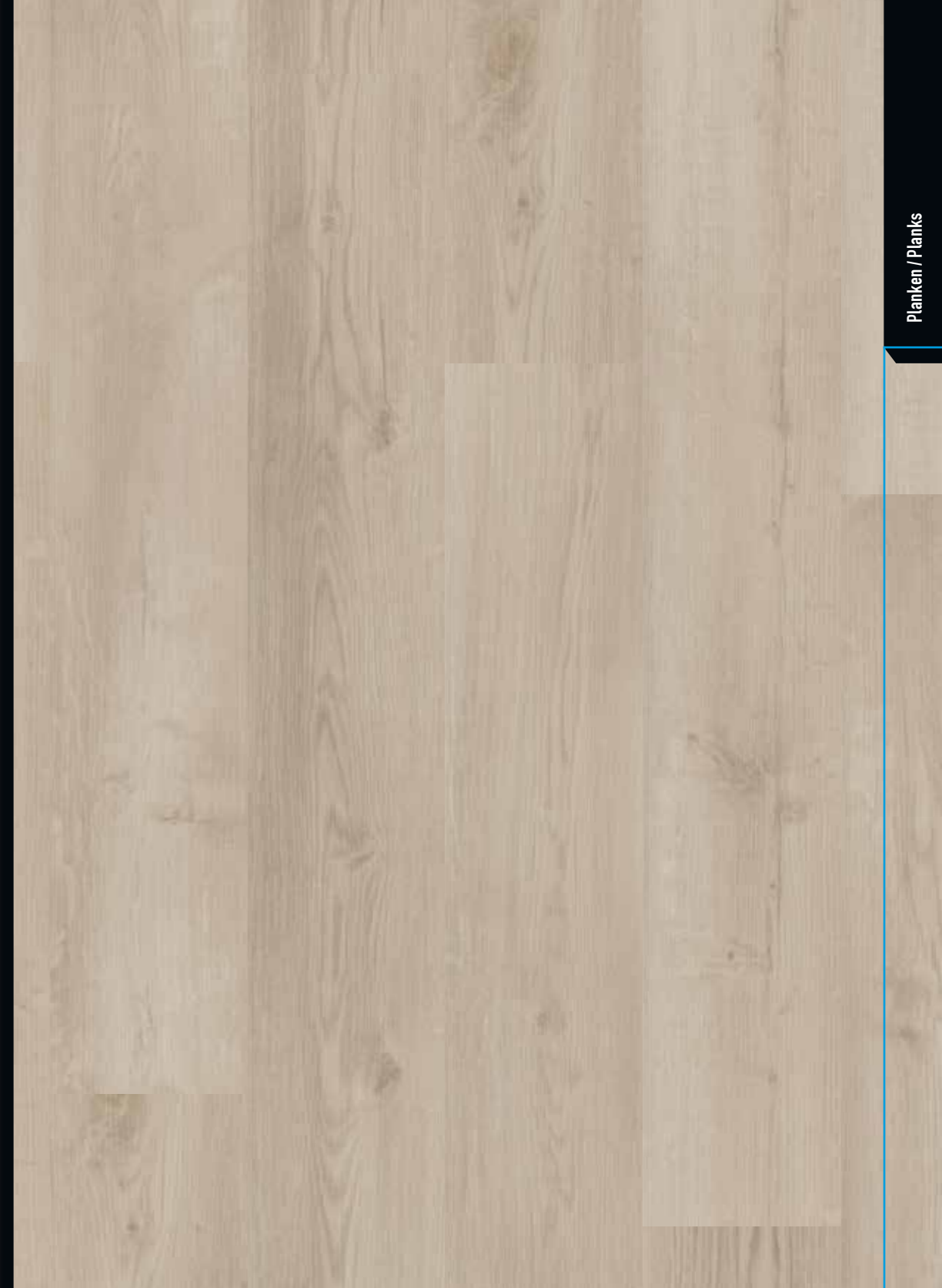

Planken / Planks

PW 3261 -/55



1219 x 183 x 2,5 mm



Mehr zum Dekor!
More about the design!

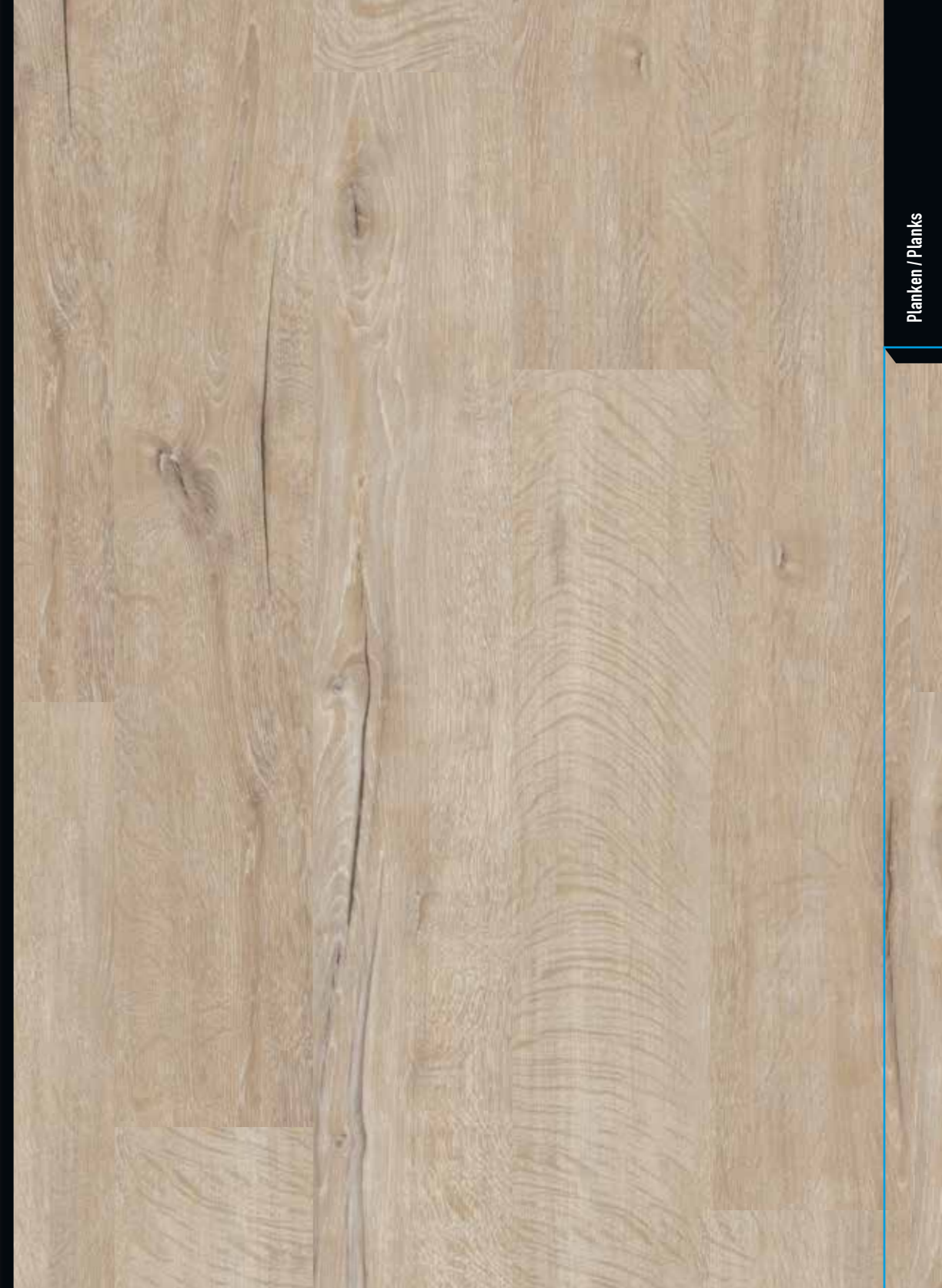

PW 3900 -/55



1219 x 183 x 2,5 mm



Mehr zum Dekor!
More about the design!

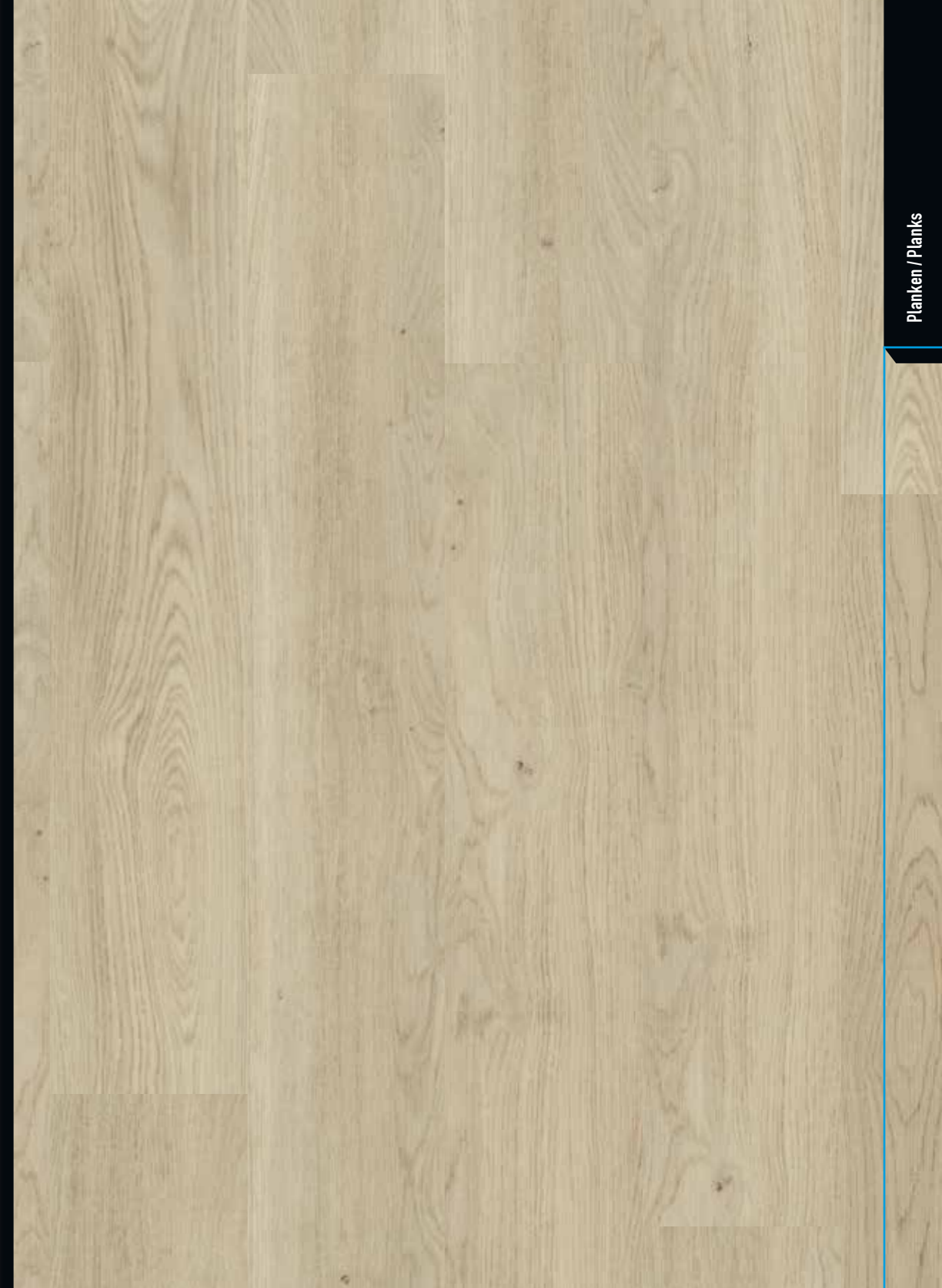

PW 1270 -/55



1219 x 183 x 2,5 mm



Mehr zum Dekor!
More about the design!



Planken / Planks

PW 1255 -/55



1219 x 183 x 2,5 mm



28
FEEL
MUSCLES USE
TRAIN HEAR
DON'T STOP
NO P
BURN FAT
SUCCE
FAILURE COMPLAINS
NO EXCUSES
TODAY AT 8:00P



Mehr zum Dekor!
More about the design!

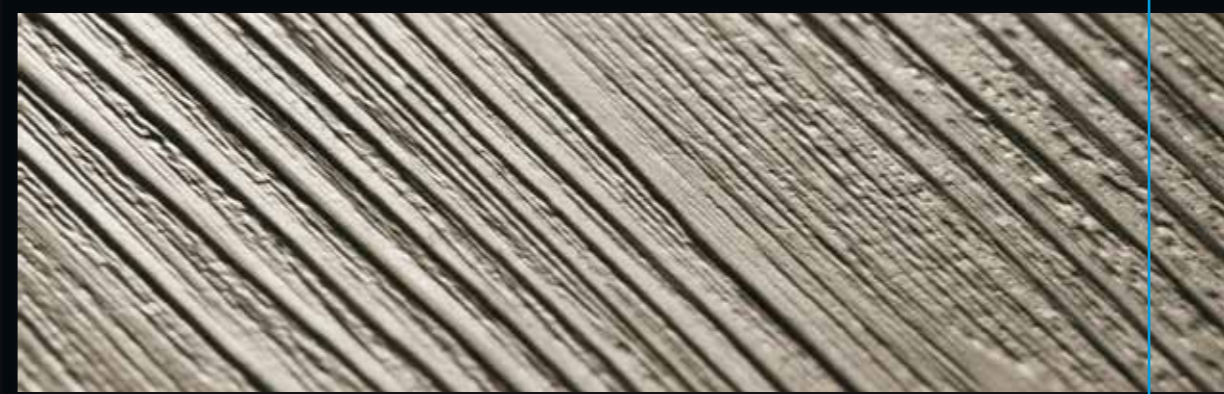
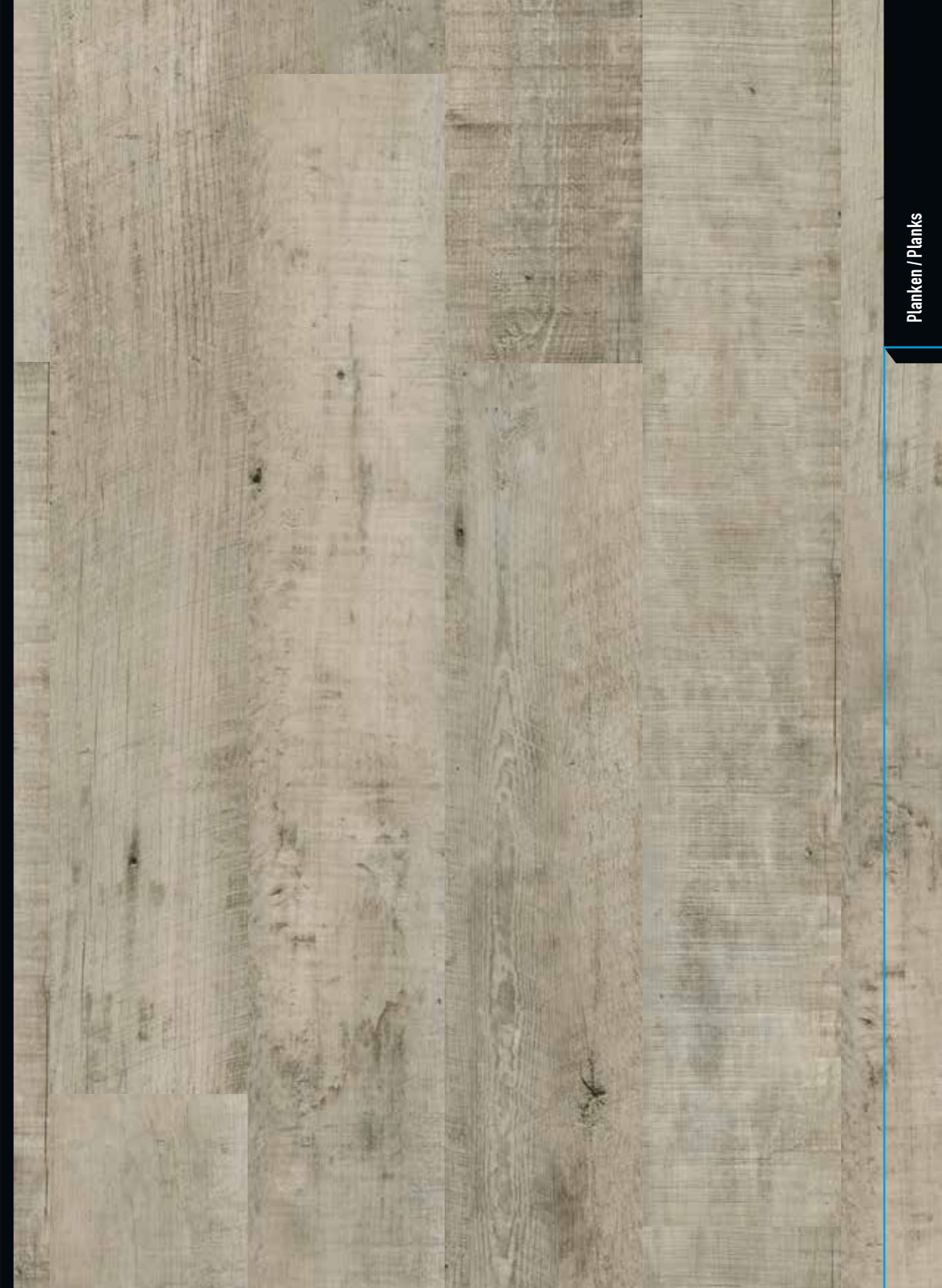

Planken / Planks

PW 3079 -/55



1219 x 183 x 2,5 mm



Mehr zum Dekor!
More about the design!

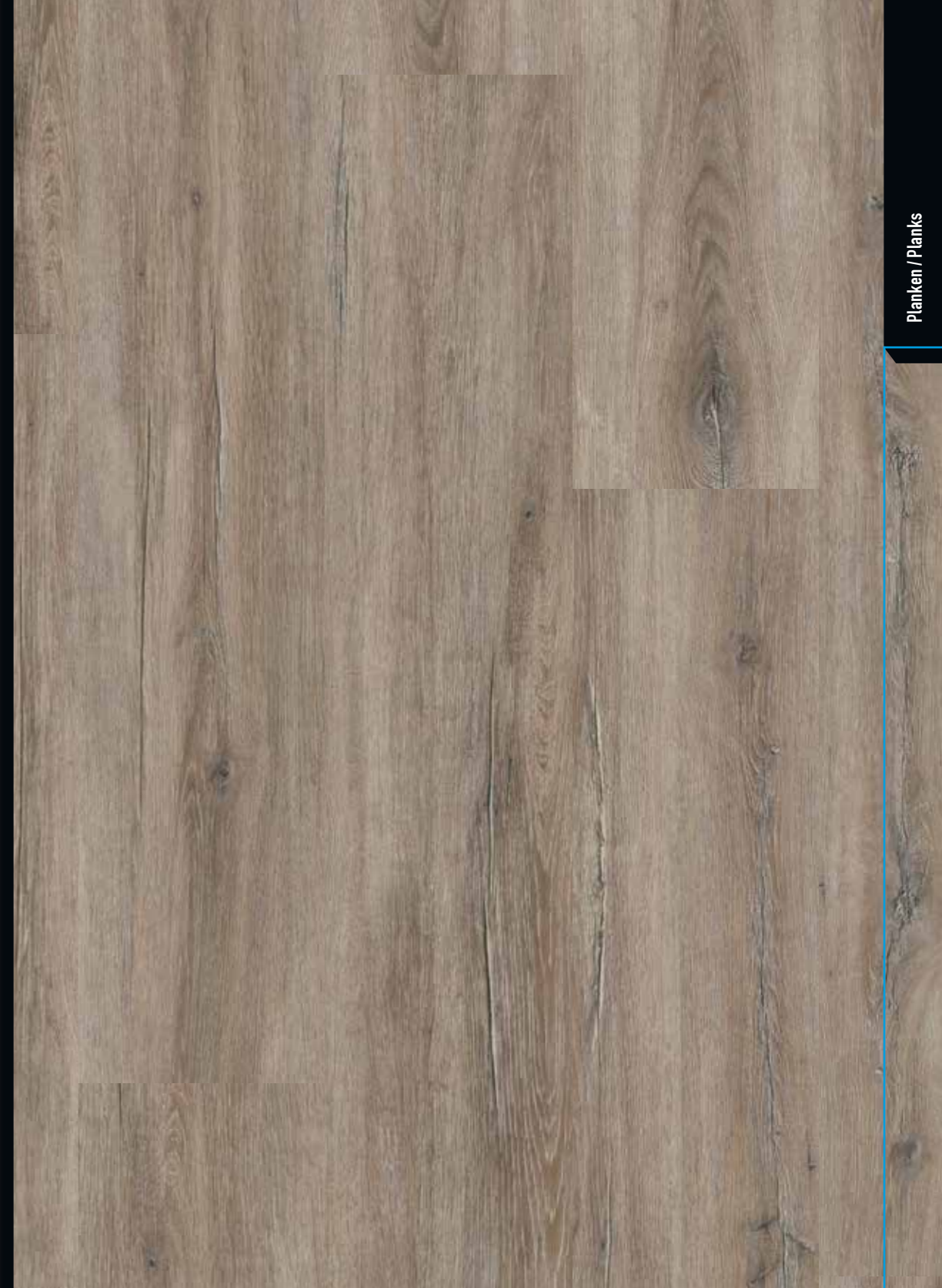

PW 3912 -/55



1219 x 228 x 2,5 mm



Mehr zum Dekor!
More about the design!



PW 1275 -/55



1219 x 183 x 2,5 mm



Mehr zum Dekor!
More about the design!

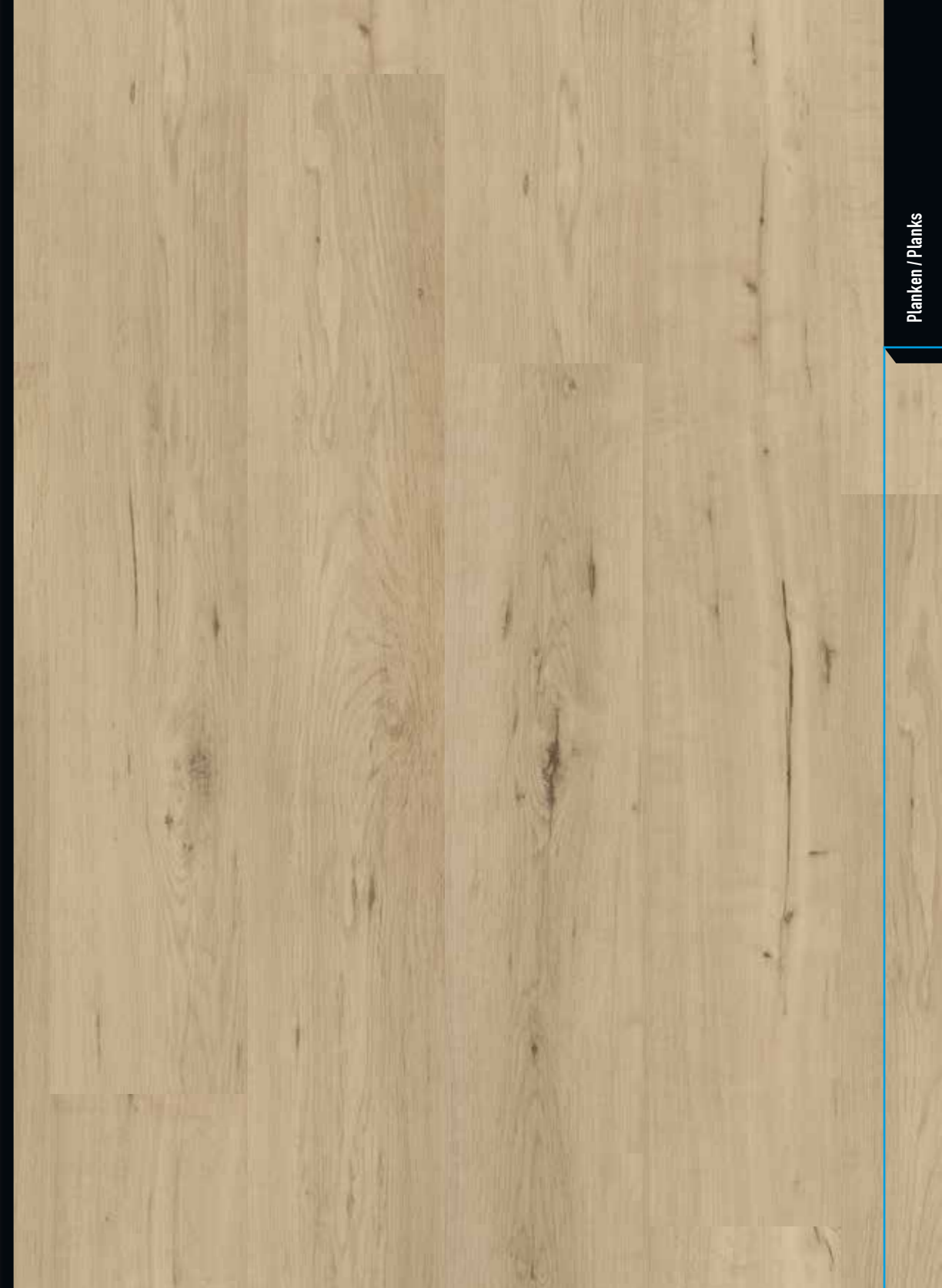

PW 1380 -/55



1219 x 183 x 2,5 mm



Mehr zum Dekor!
More about the design!

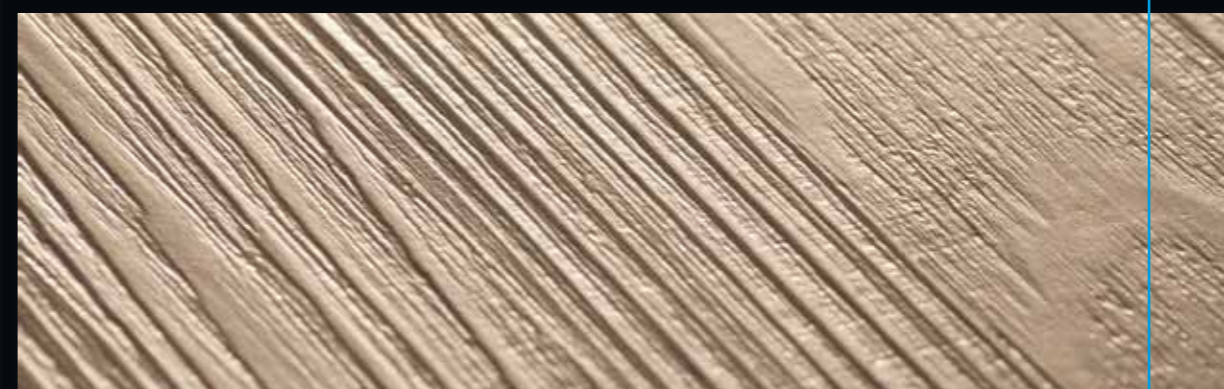
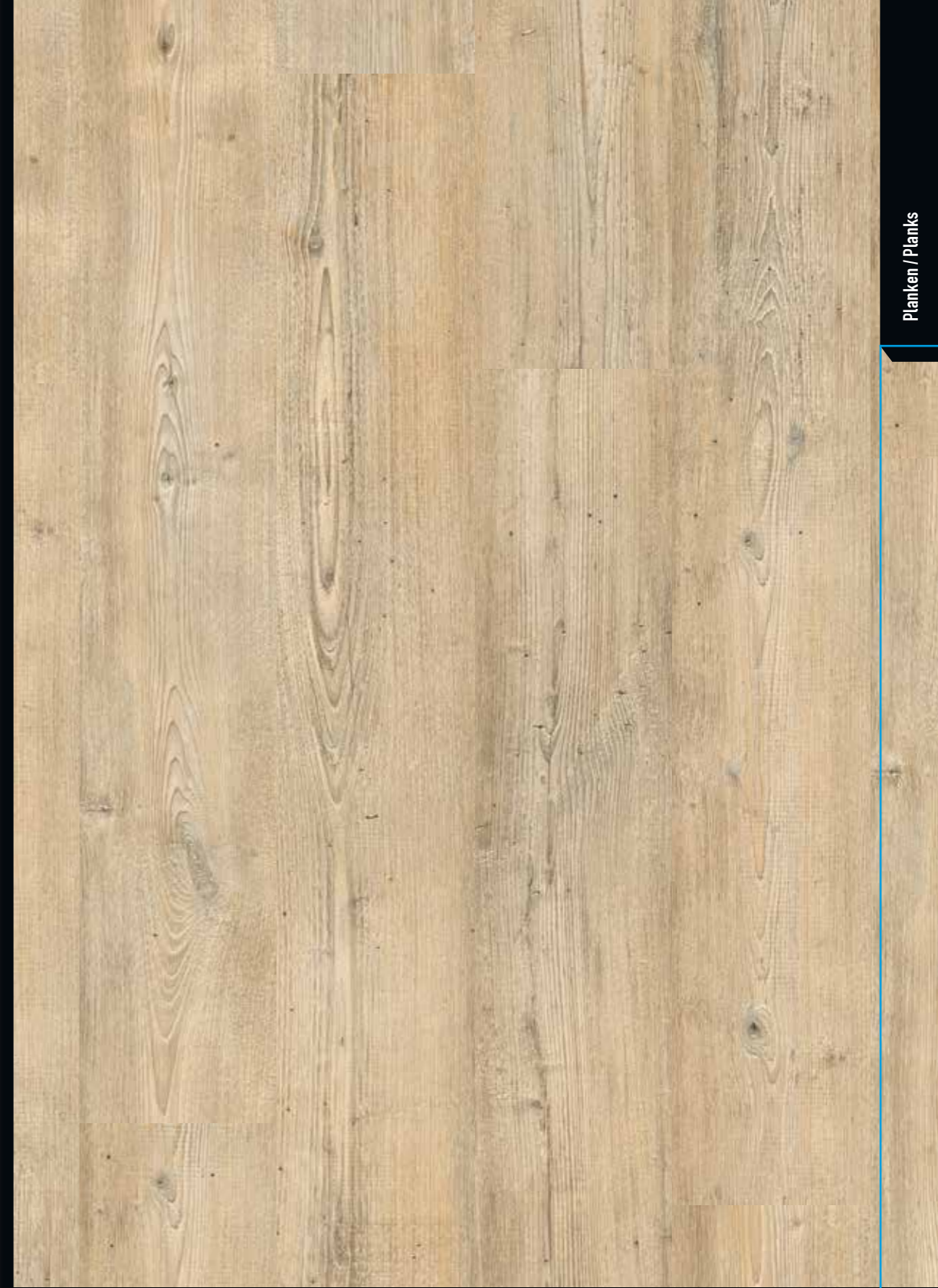

PW 3021 -/55

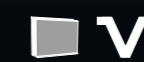

1219 x 183 x 2,5 mm



Mehr zum Dekor!
More about the design!

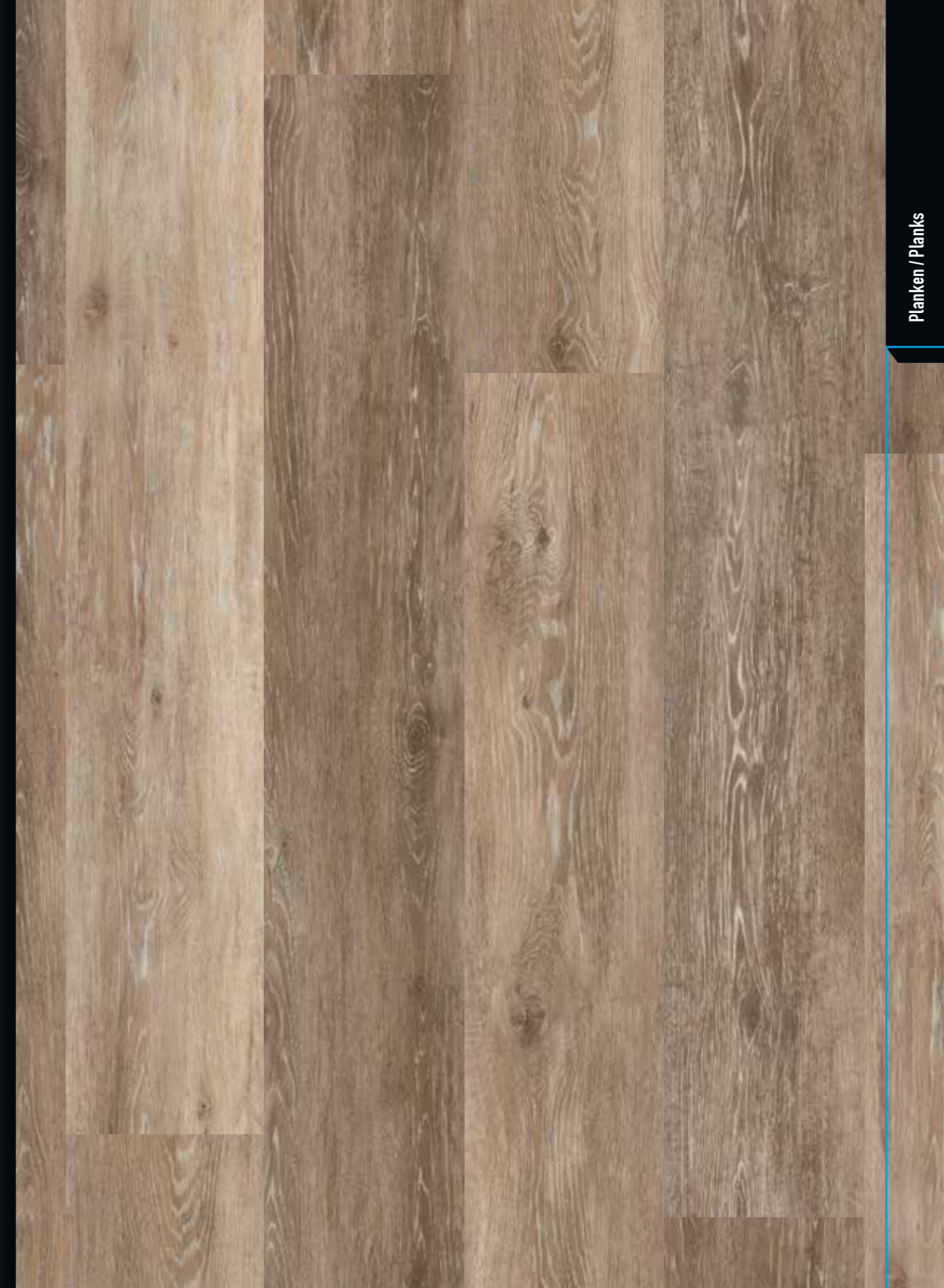

Planken / Planks

PW 1260 -/55



1219 x 183 x 2,5 mm



Mehr zum Dekor!
More about the design!

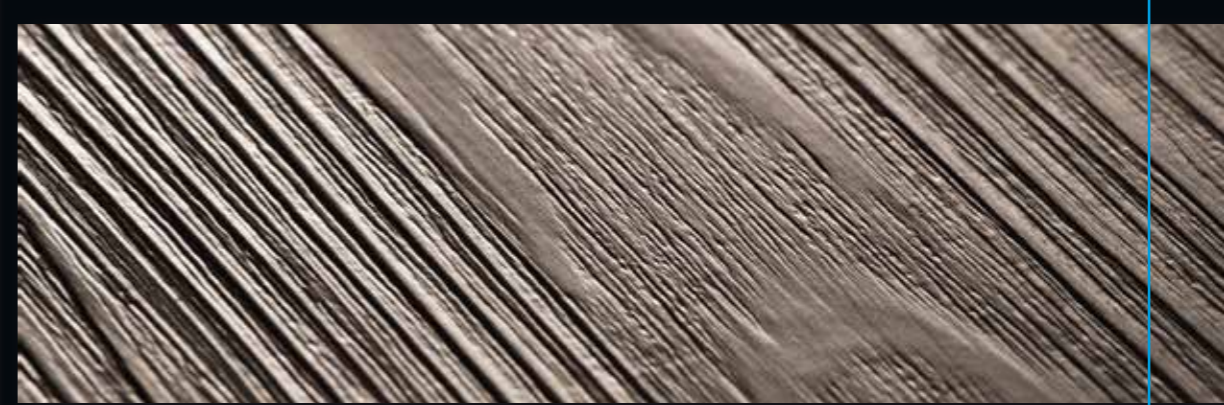
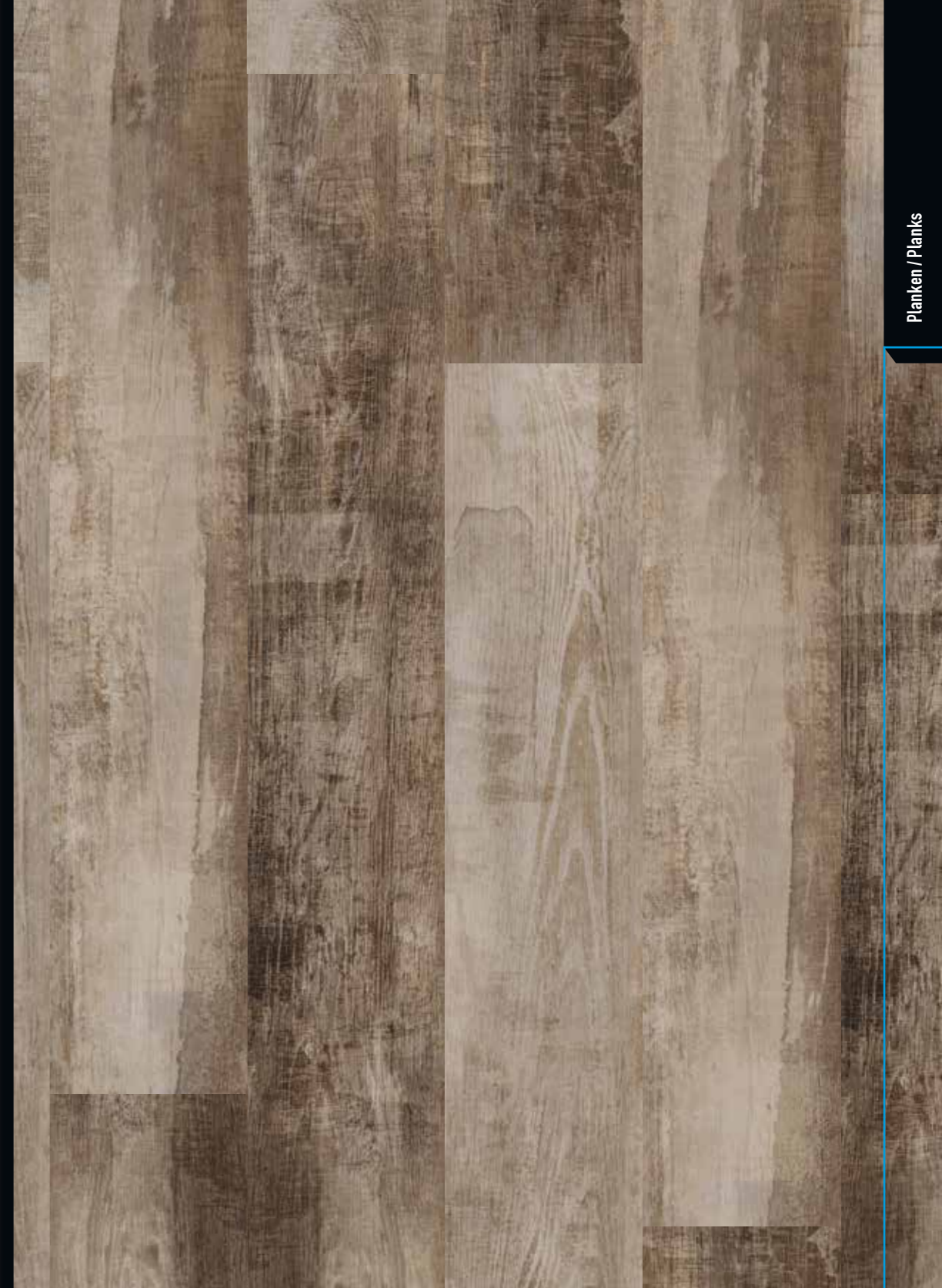

PW 2980 -/55



1219 x 183 x 2,5 mm



Mehr zum Dekor!
More about the design!

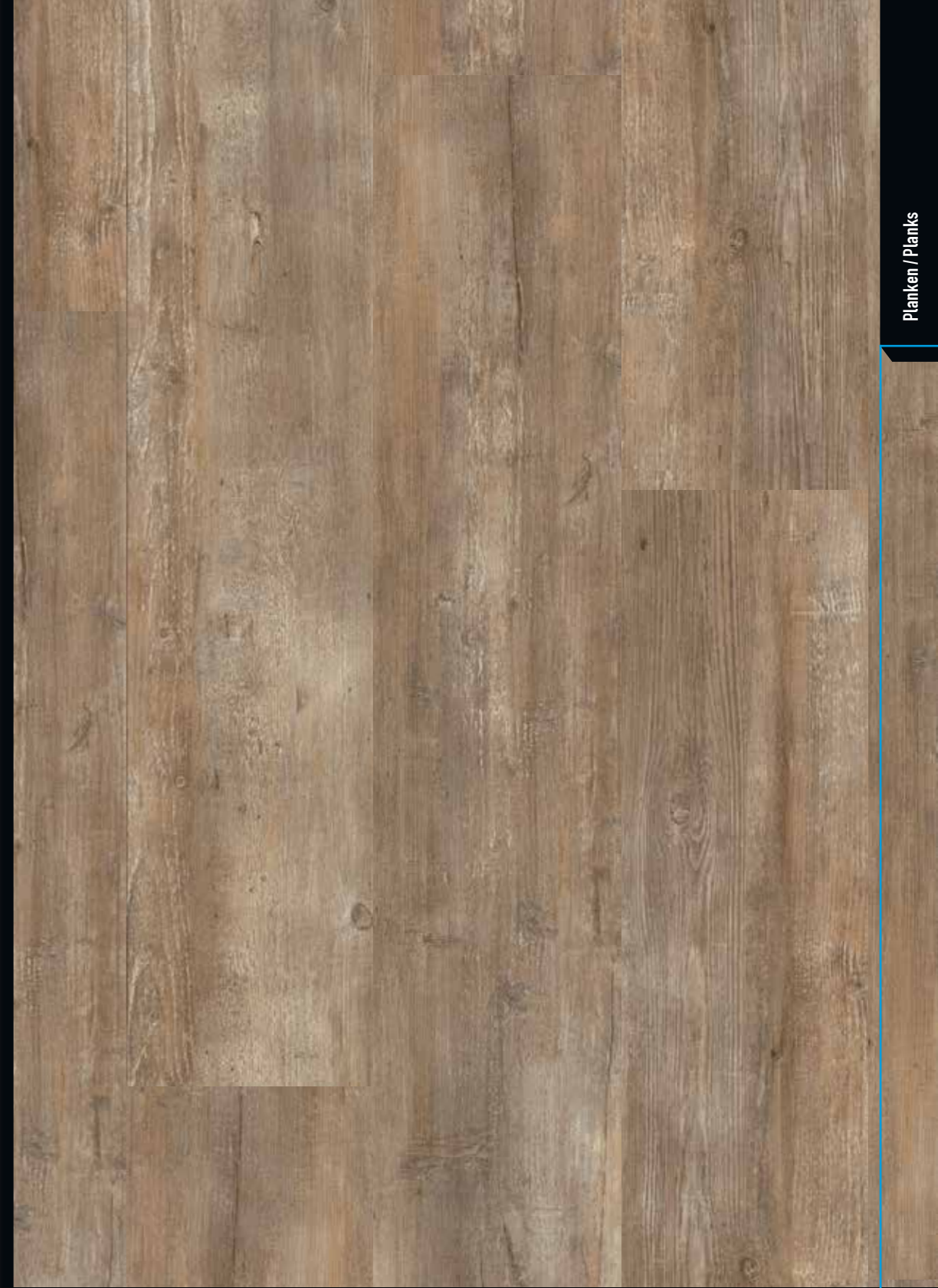

Planken / Planks

PW 3810 -/55



1219 x 228 x 2,5 mm



Mehr zum Dekor!
More about the design!

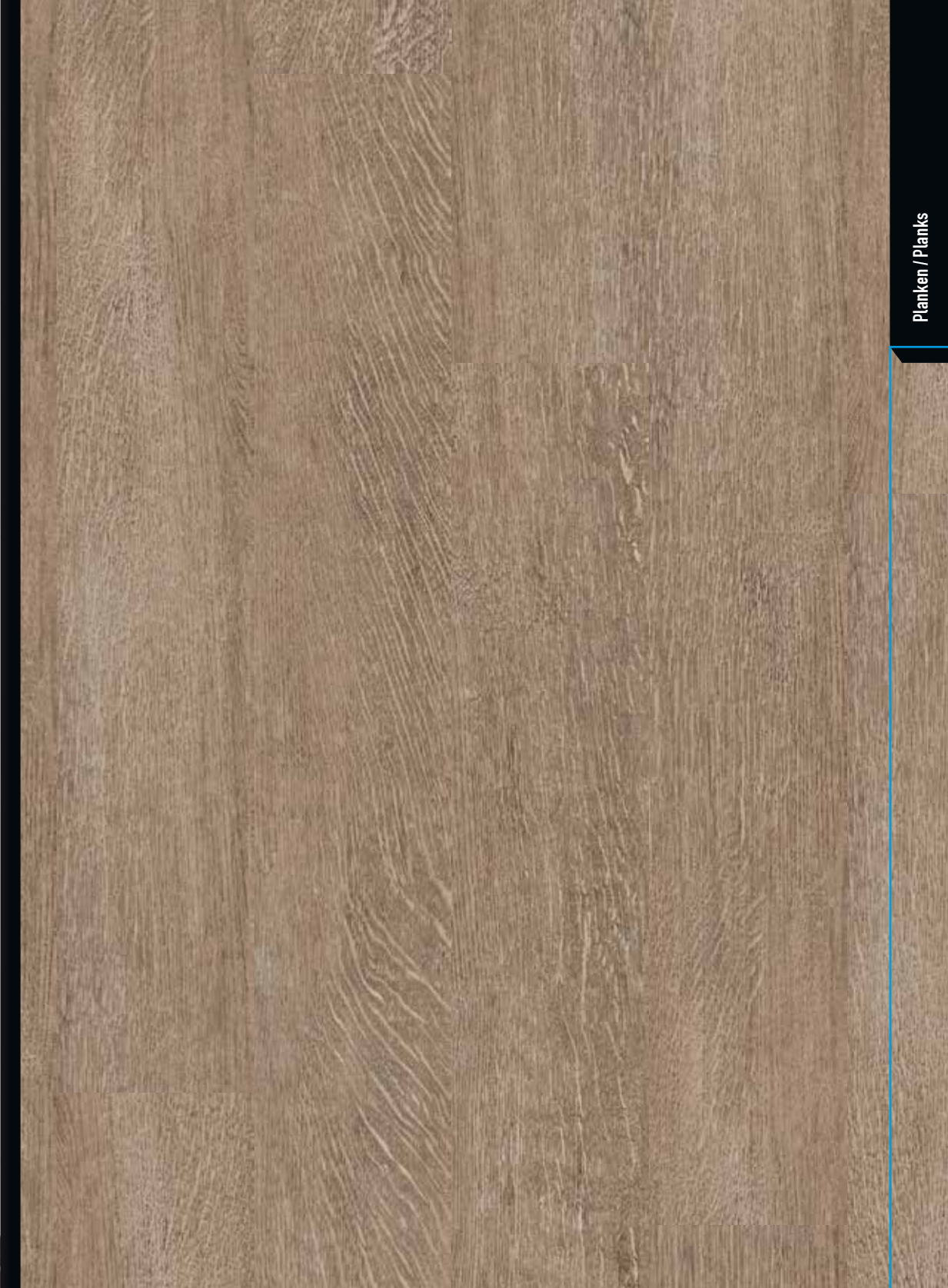

PW 1246 -/55



1219 x 183 x 2,5 mm



Mehr zum Dekor!
More about the design!



Mit optionalen schwarzen Fugenprofilen
With optional feature strips black

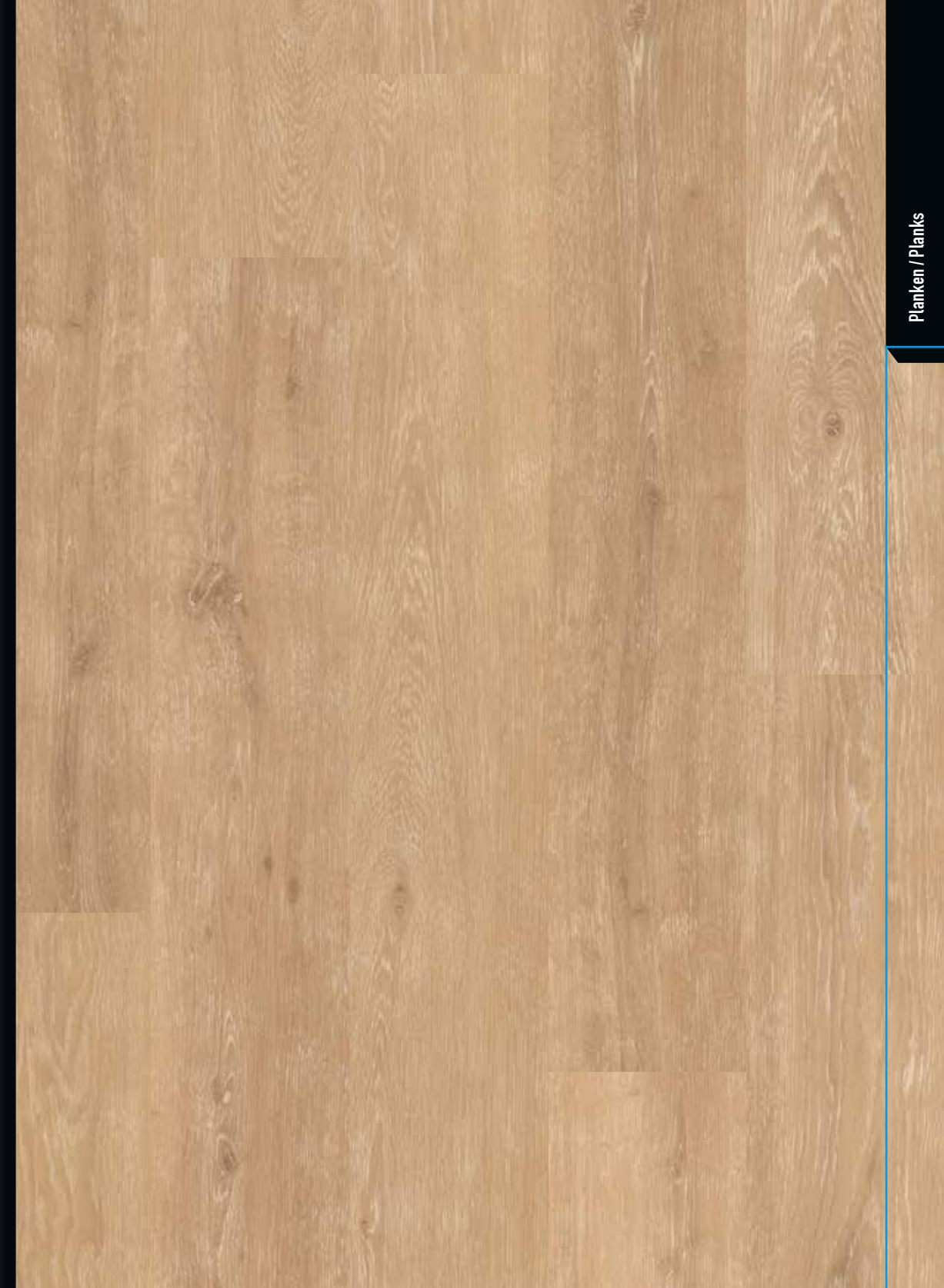

PW 3100 -/55



1219 x 183 x 2,5 mm



Mehr zum Dekor!
More about the design!



Planken / Planks

PW 3110 -/55



1219 x 183 x 2,5 mm



Mehr zum Dekor!
More about the design!

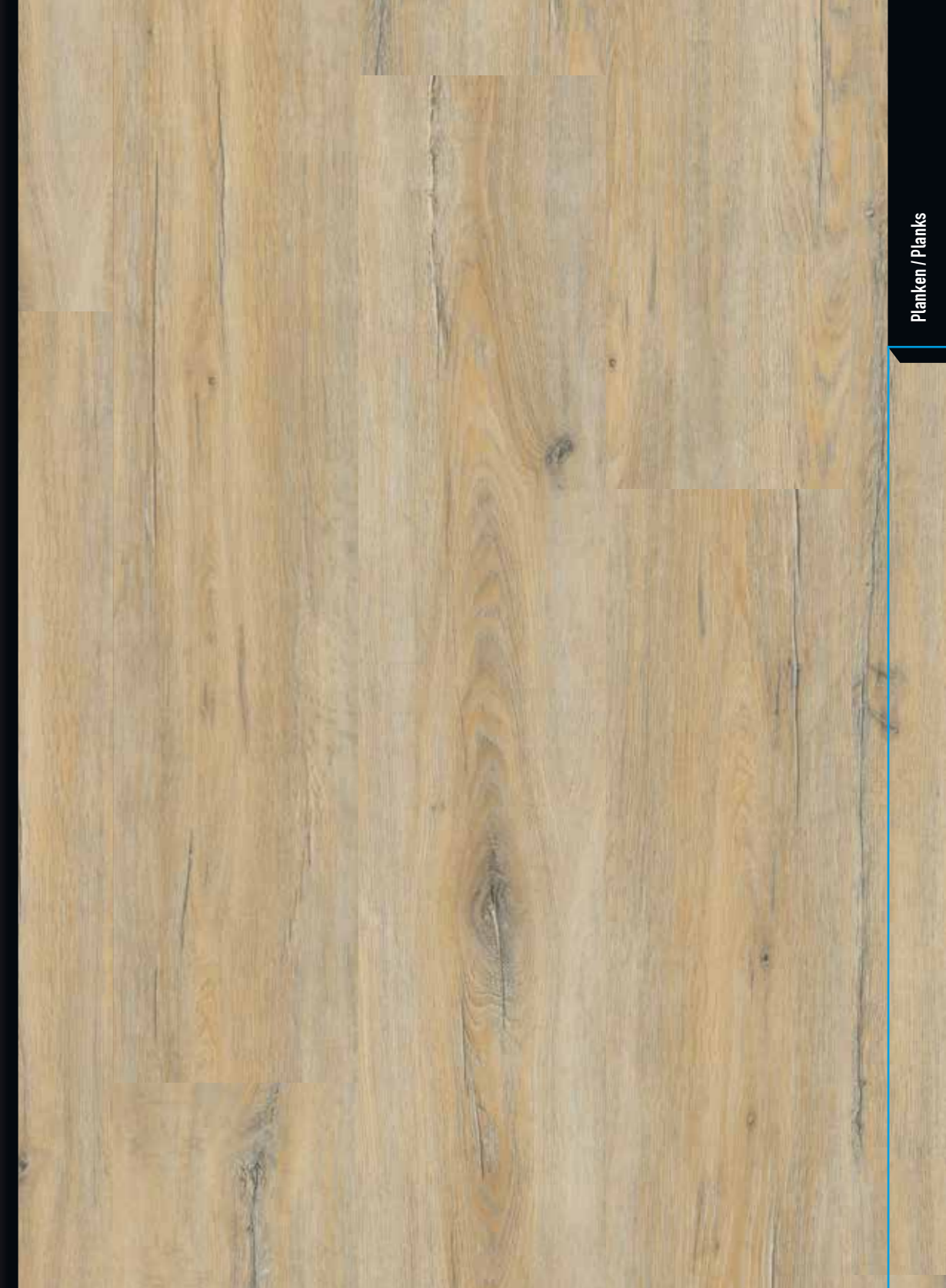

PW 3910 -/55



1219 x 228 x 2,5 mm



Mehr zum Dekor!
More about the design!

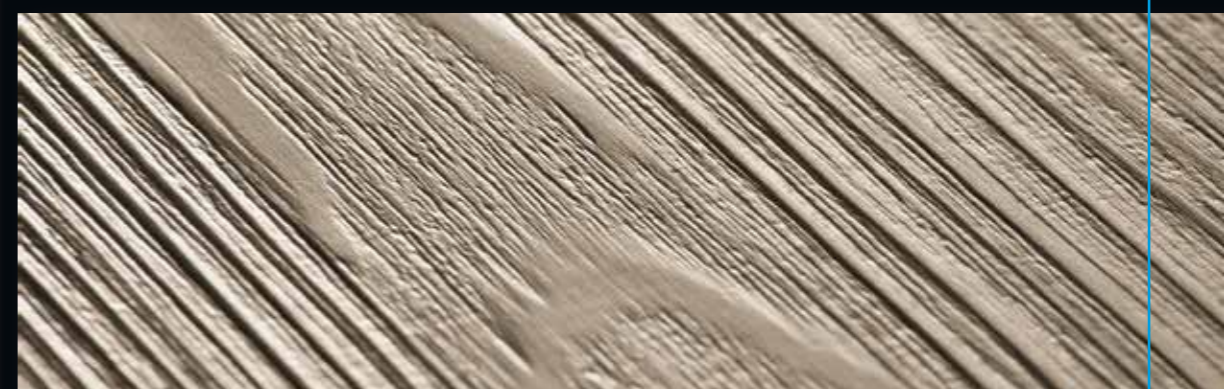
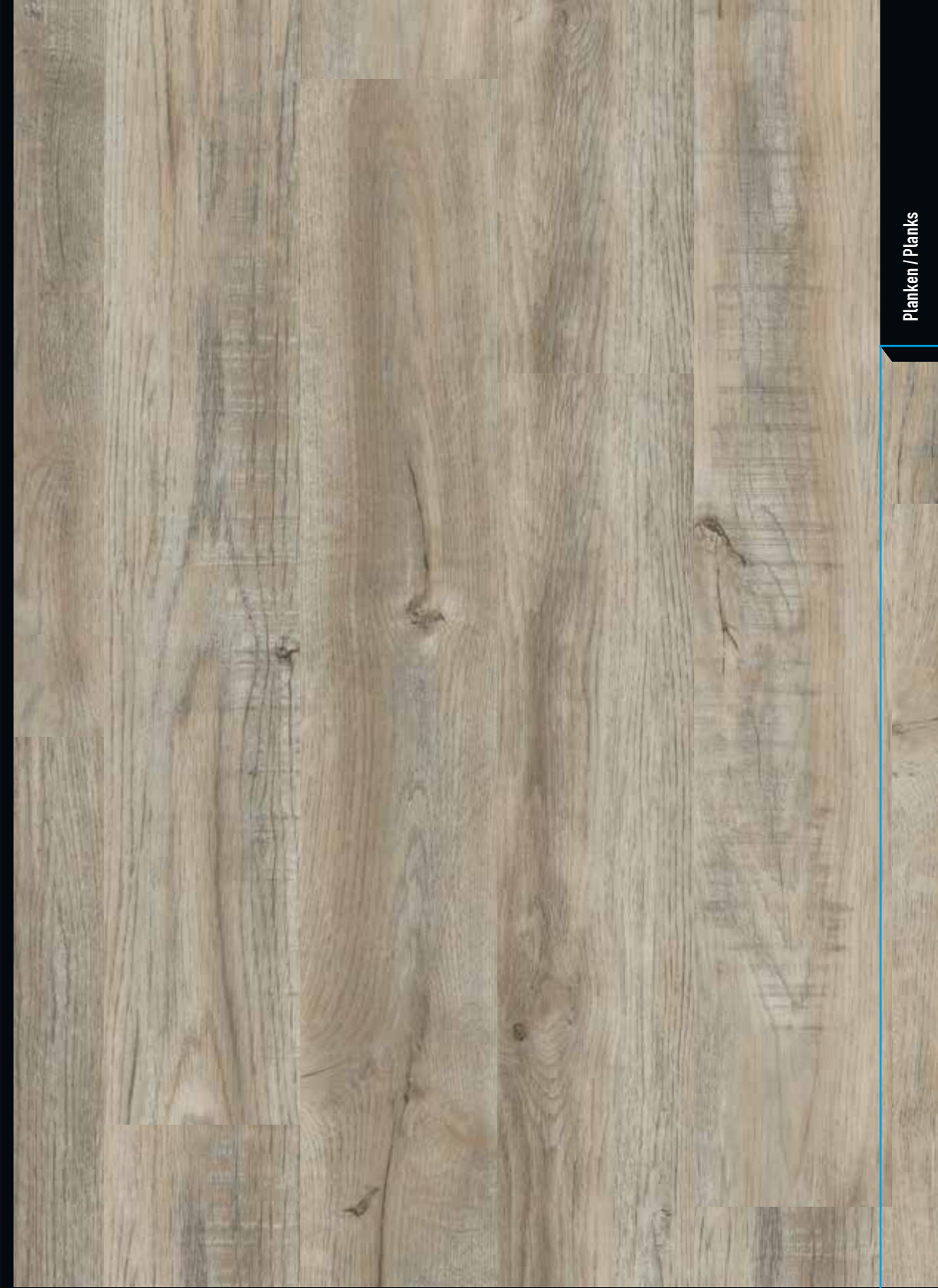

Planken / Planks

PW 3140 -/55

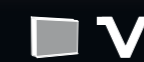

1219 x 183 x 2,5 mm



Mehr zum Dekor!
More about the design!



PW 1265 -/55



1219 x 183 x 2,5 mm



Mehr zum Dekor!
More about the design!

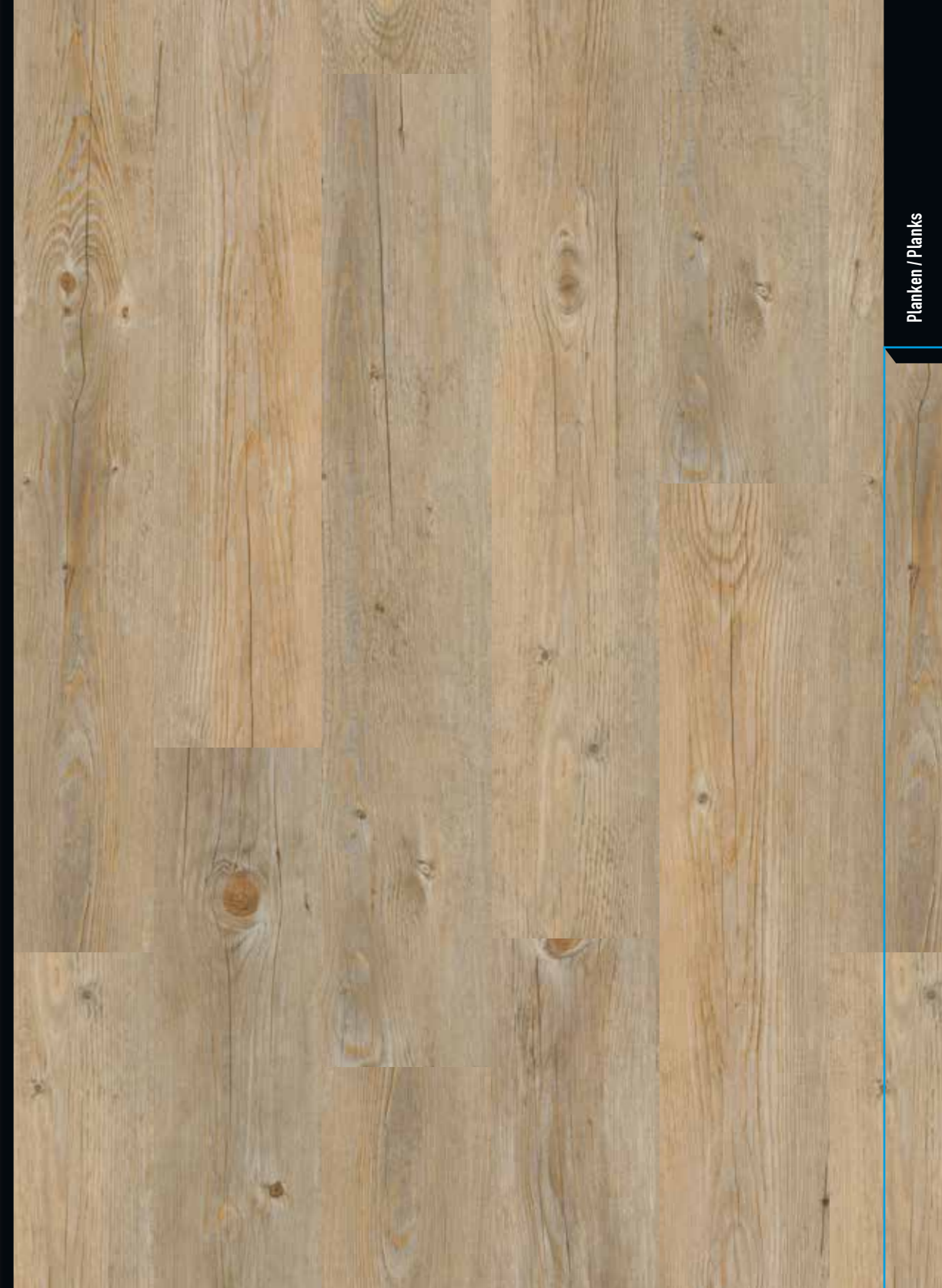

Planken / Planks

PW 3020 -/55



914 x 152 x 2,5 mm



Mehr zum Dekor!
More about the design!

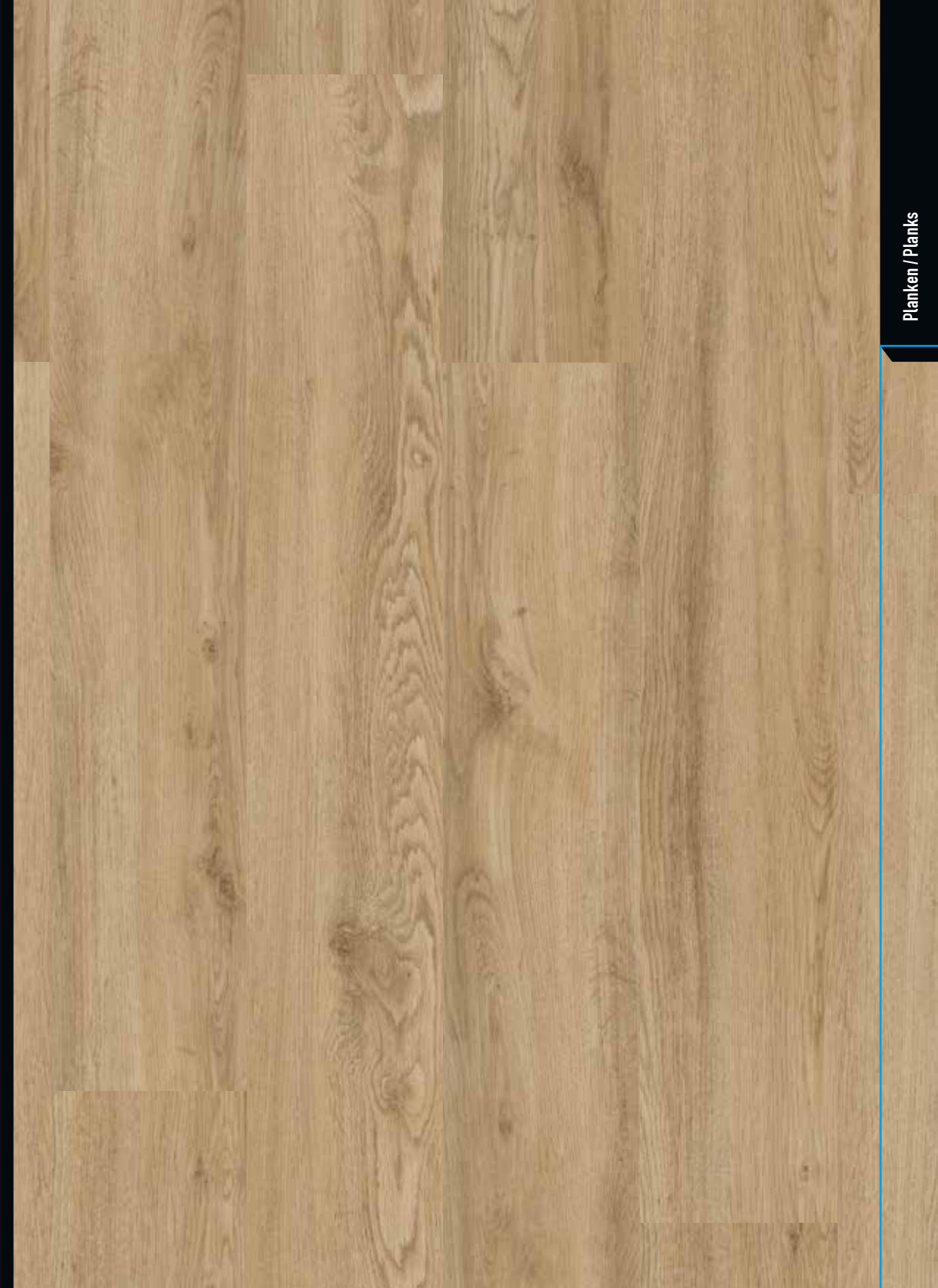

PW 3240 -/55



1219 x 183 x 2,5 mm



Mehr zum Dekor!
More about the design!

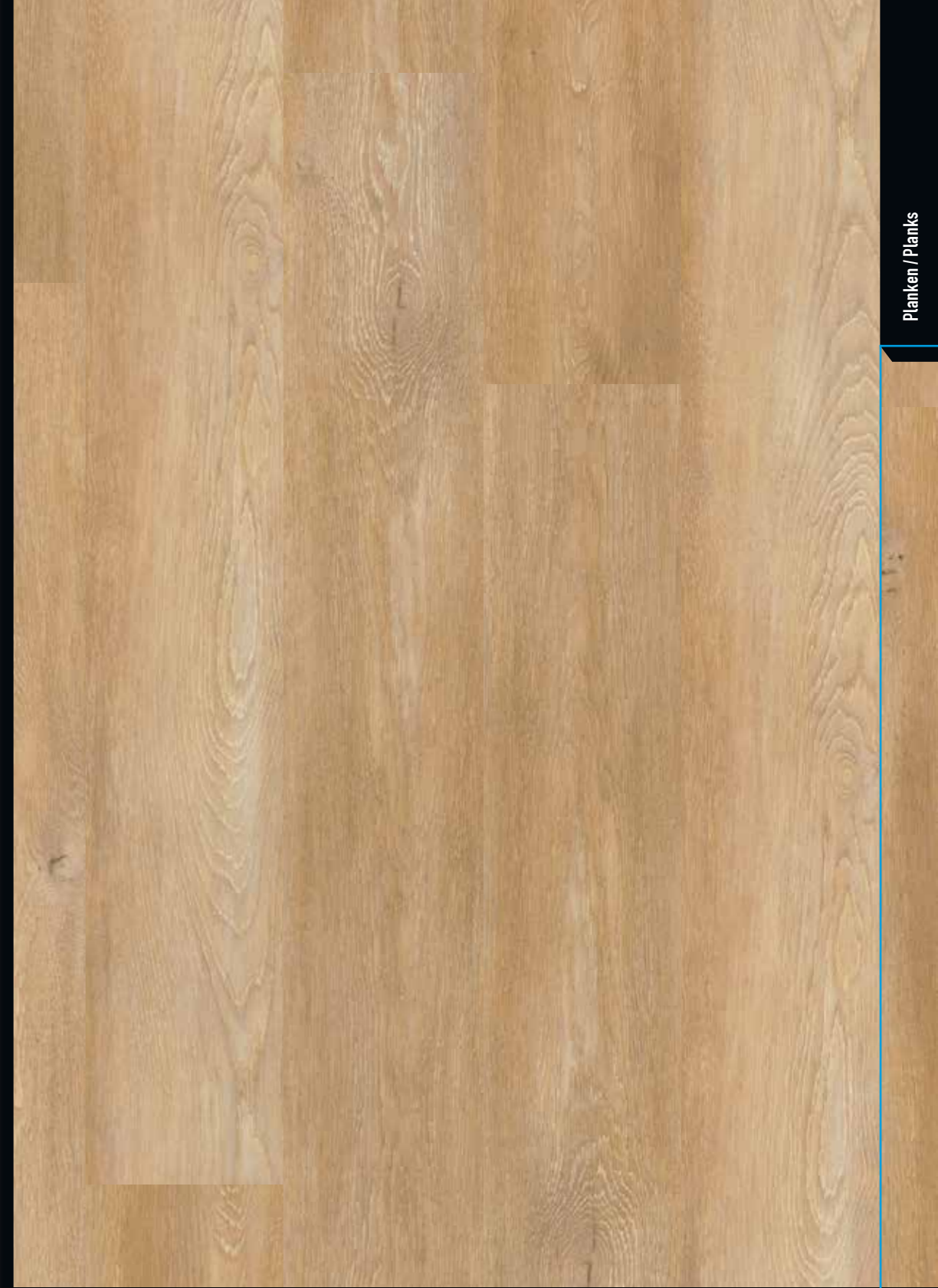

PW 1250 -/55



1219 x 183 x 2,5 mm



Mehr zum Dekor!
More about the design!

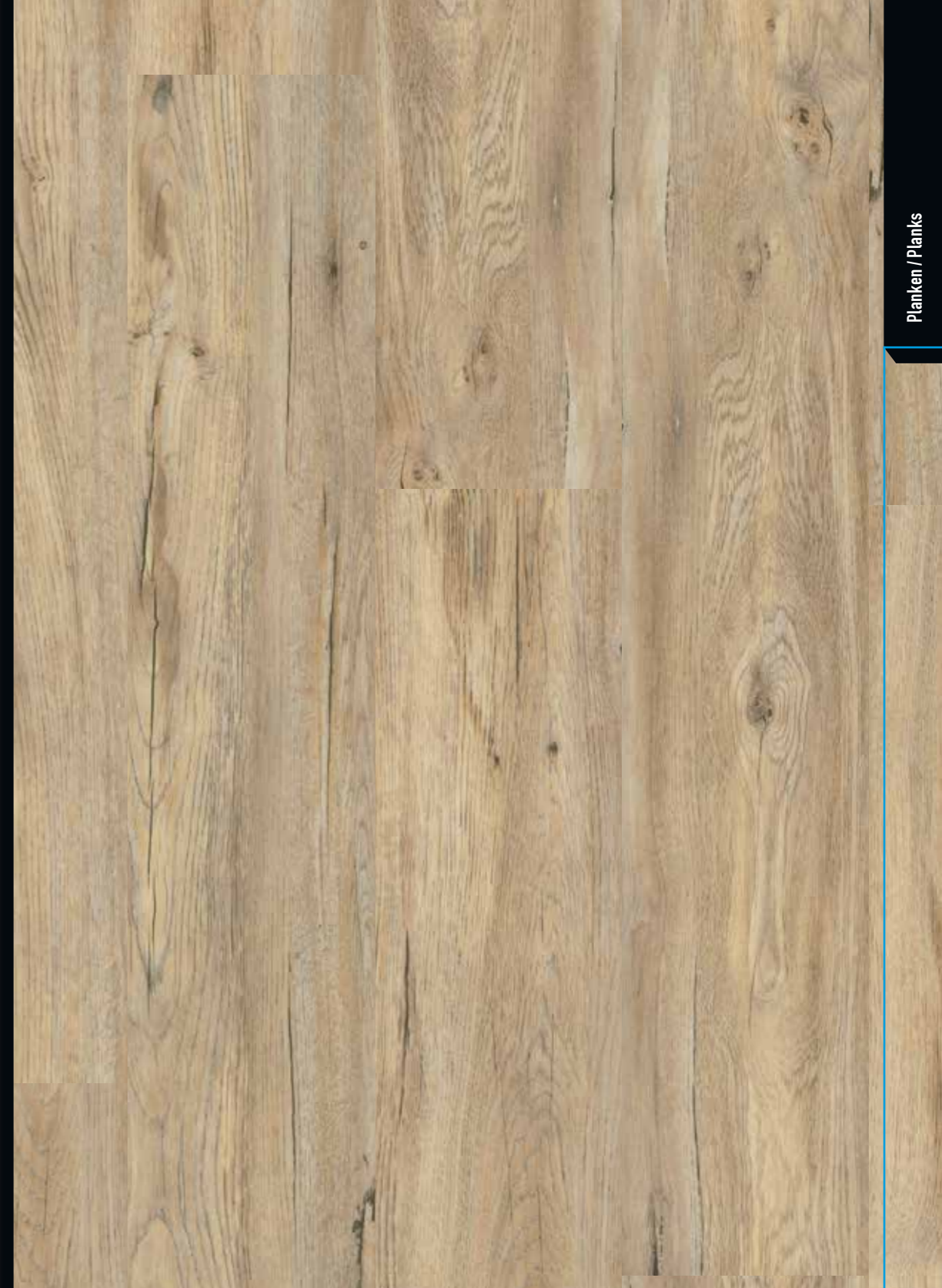

PW 3230 -/55



1219 x 228 x 2,5 mm



Mehr zum Dekor!
More about the design!

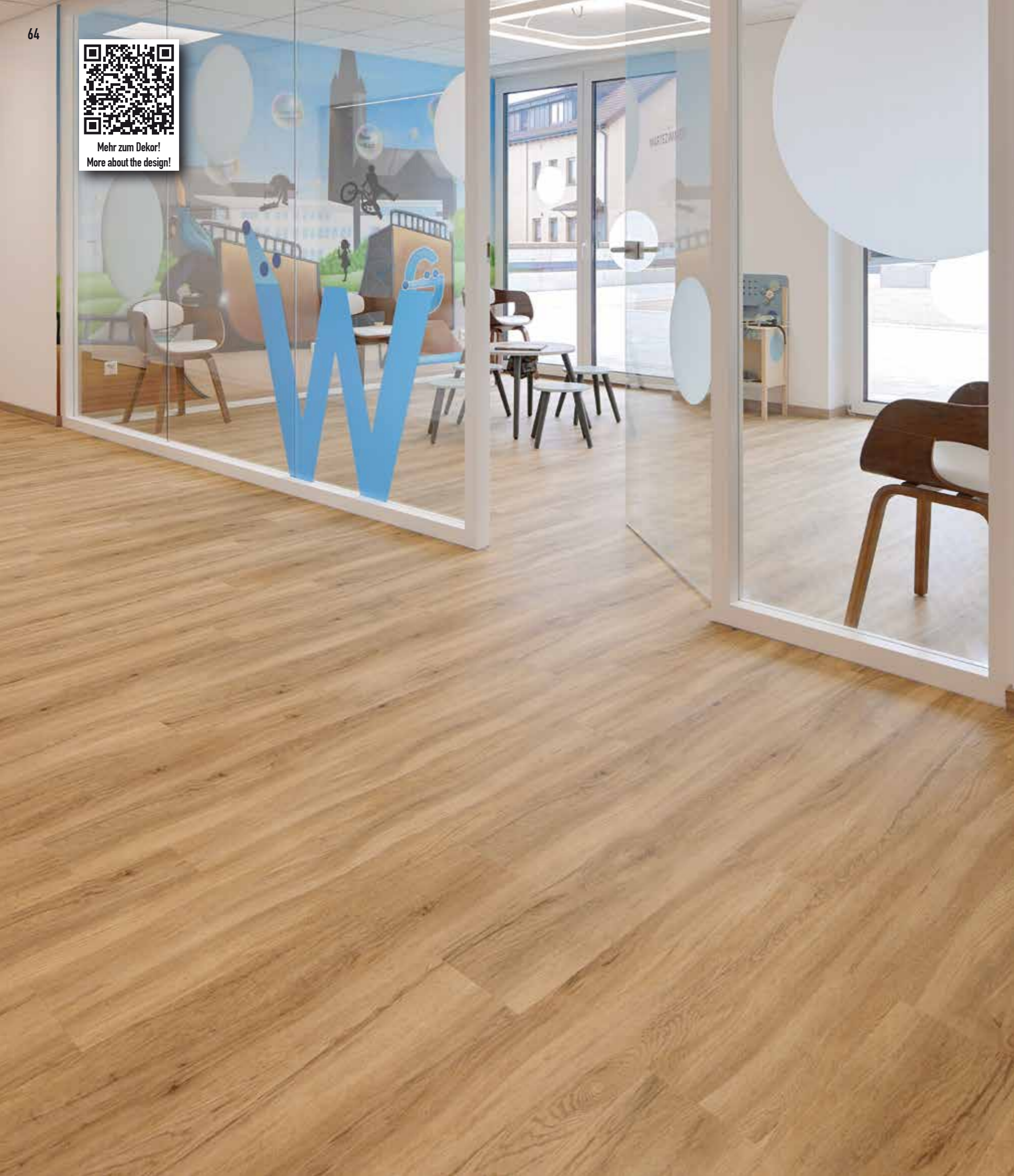

Planken / Planks

PW 3220 -/55



1219 x 183 x 2,5 mm



Mehr zum Dekor!
More about the design!

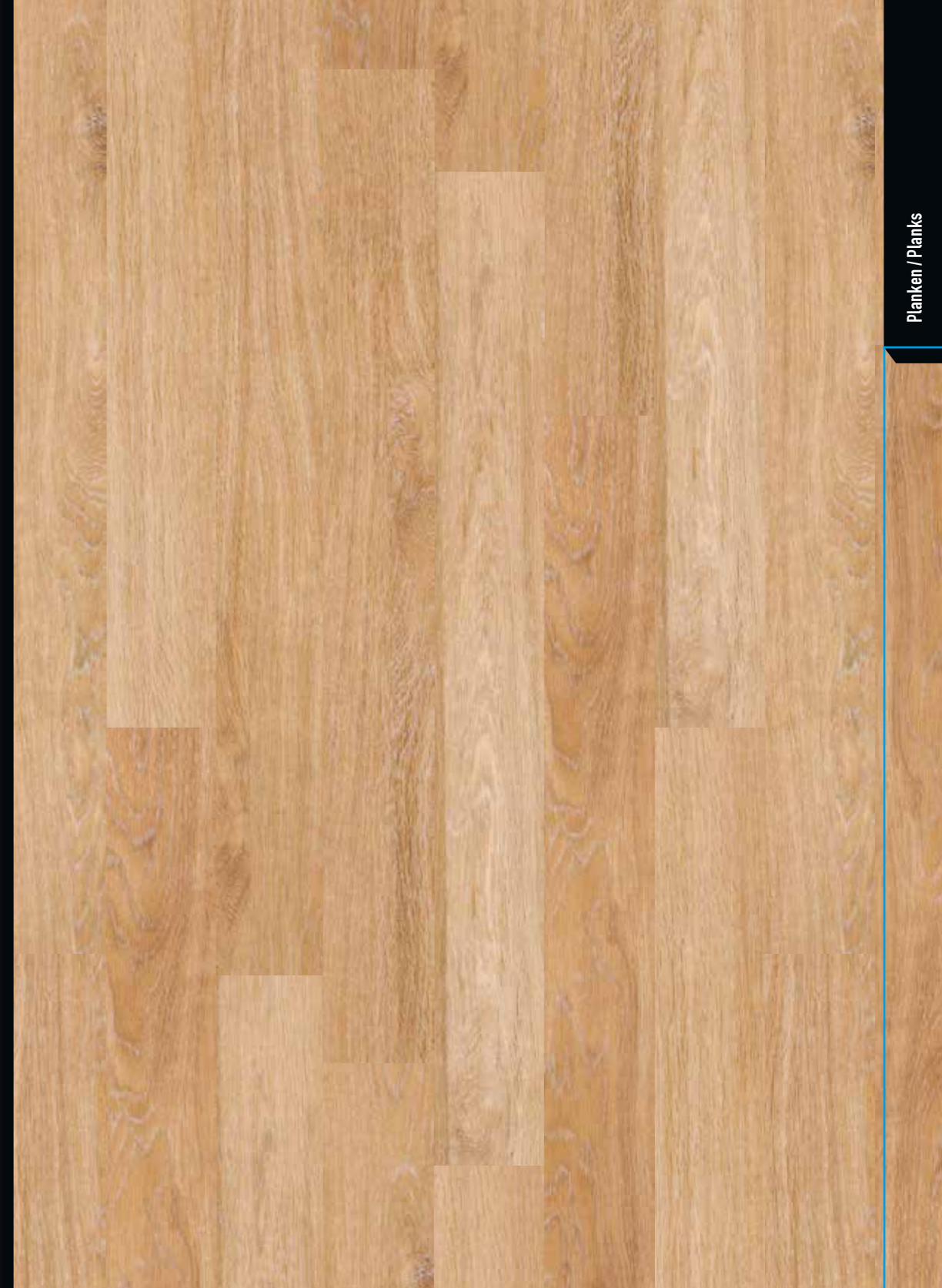

PW 1633 -/55



914 x 102 x 2,5 mm



Mehr zum Dekor!
More about the design!

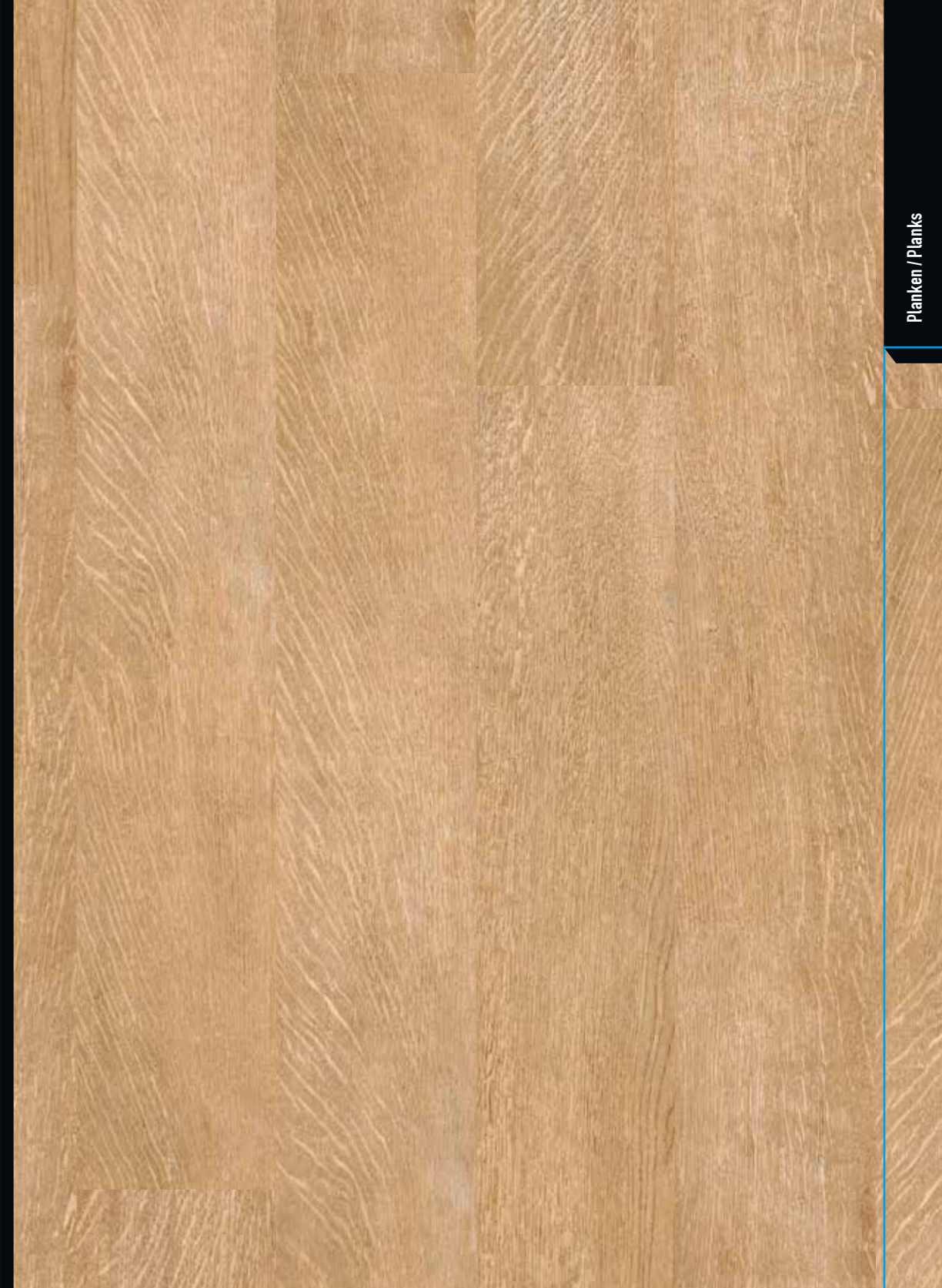

PW 1245 -/55



1219 x 183 x 2,5 mm



Mehr zum Dekor!
More about the design!

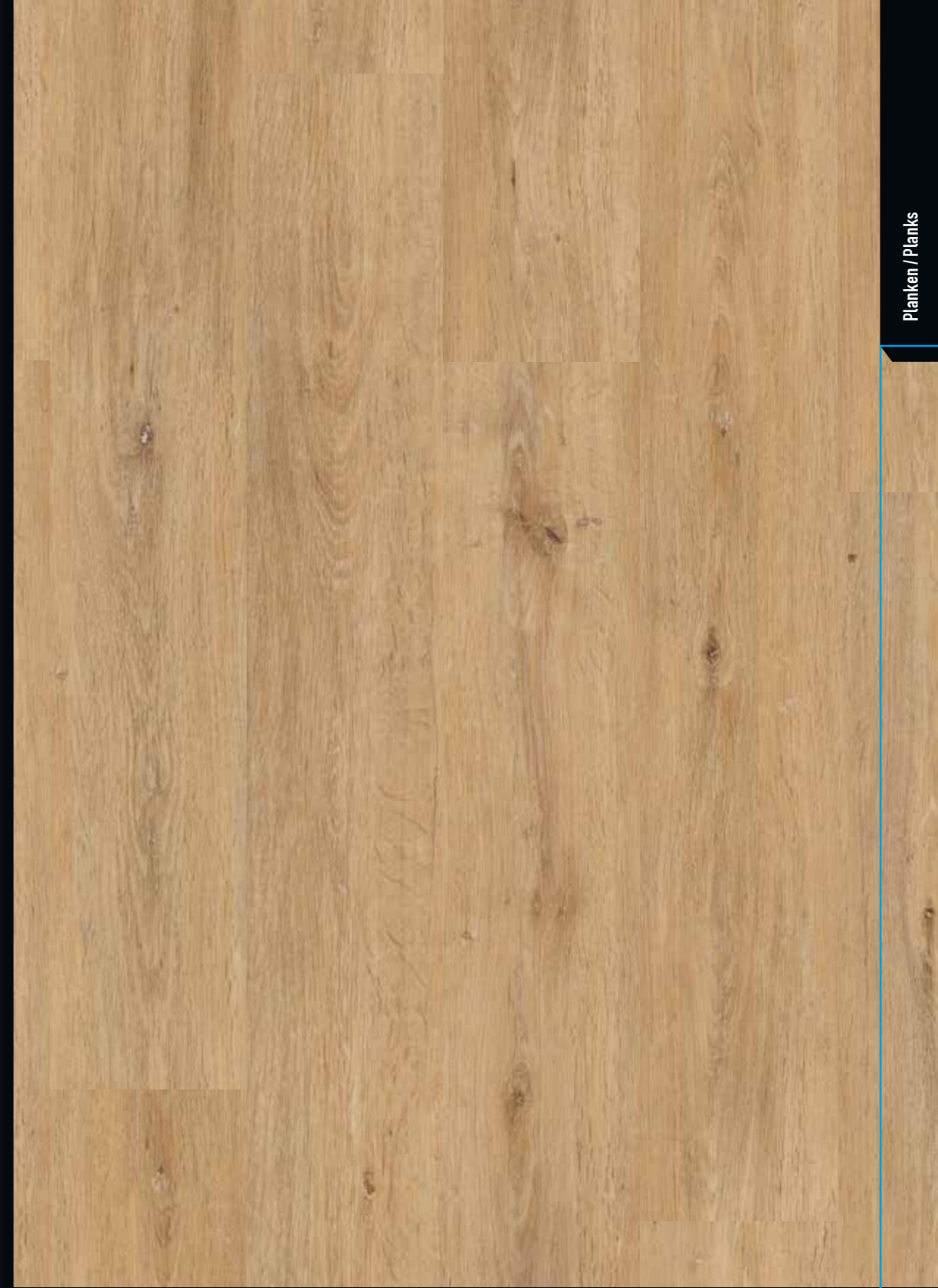

PW 3350 -/55



1219 x 183 x 2,5 mm



Mehr zum Dekor!
More about the design!

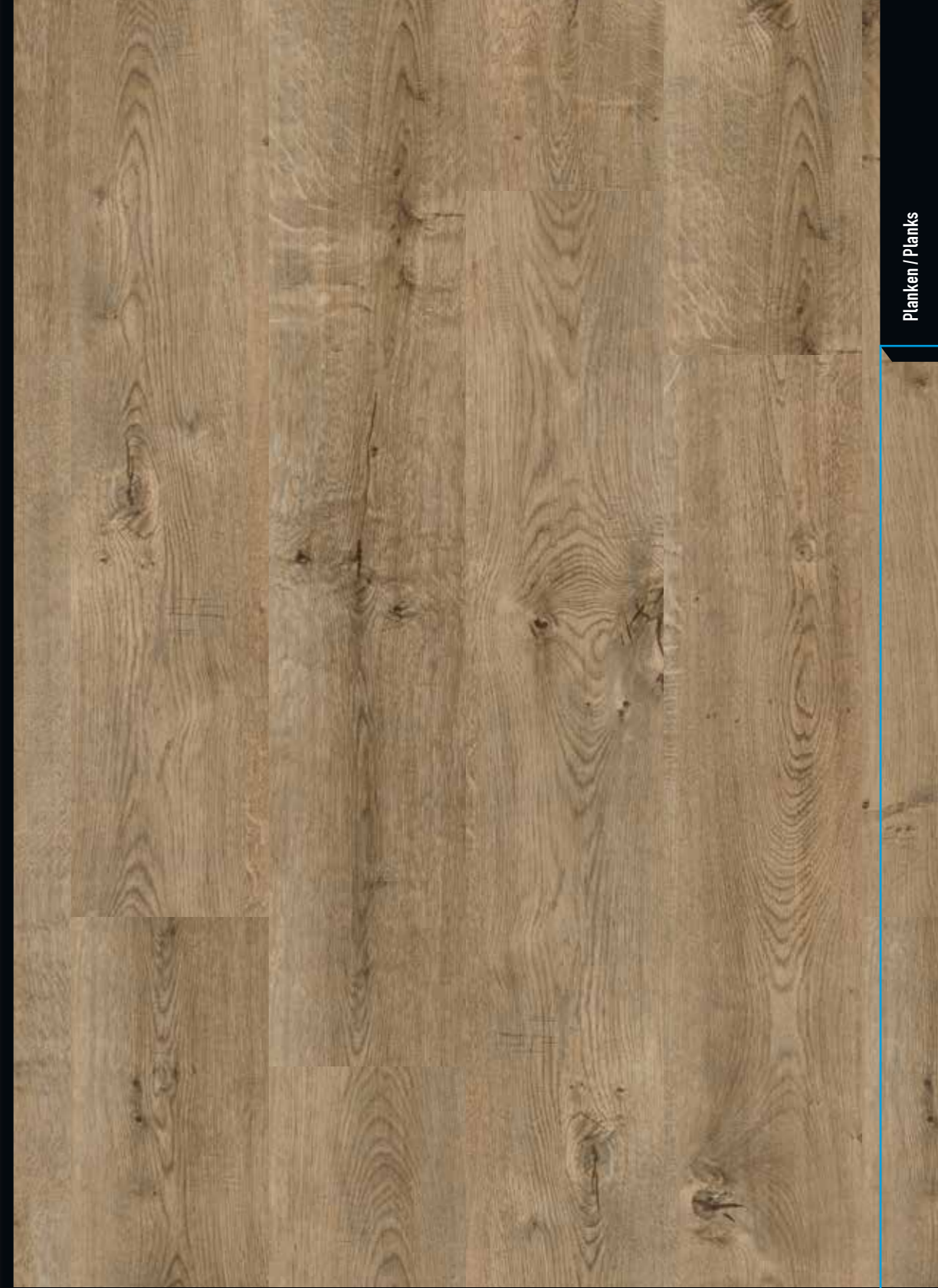

Planken / Planks

PW 3160 -/55



1219 x 183 x 2,5 mm

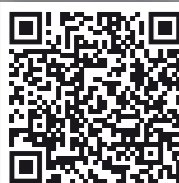

Mehr zum Dekor!
More about the design!

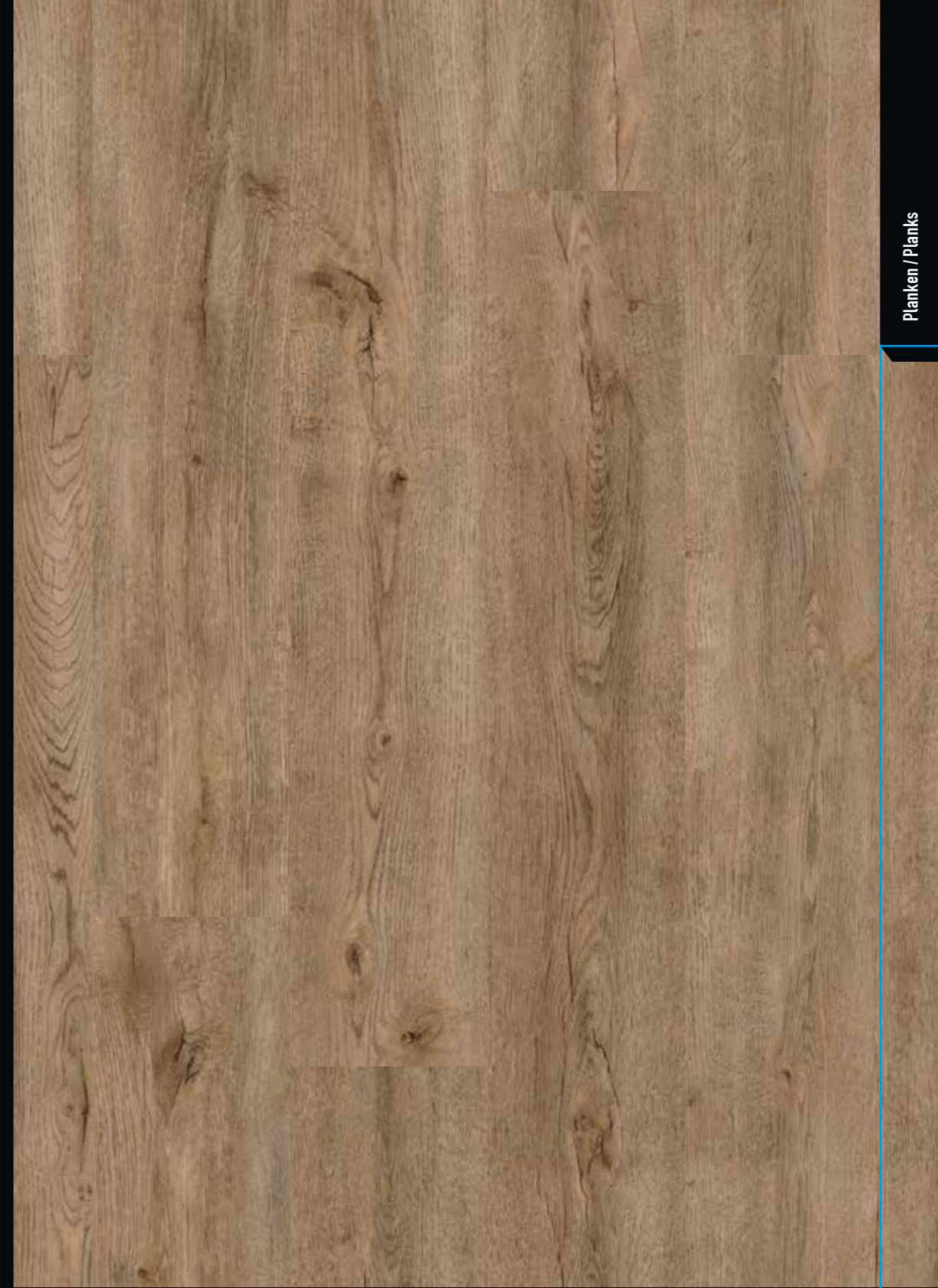

Planken / Planks

PW 3150 -/55



1219 x 183 x 2,5 mm



Mehr zum Dekor!
More about the design!

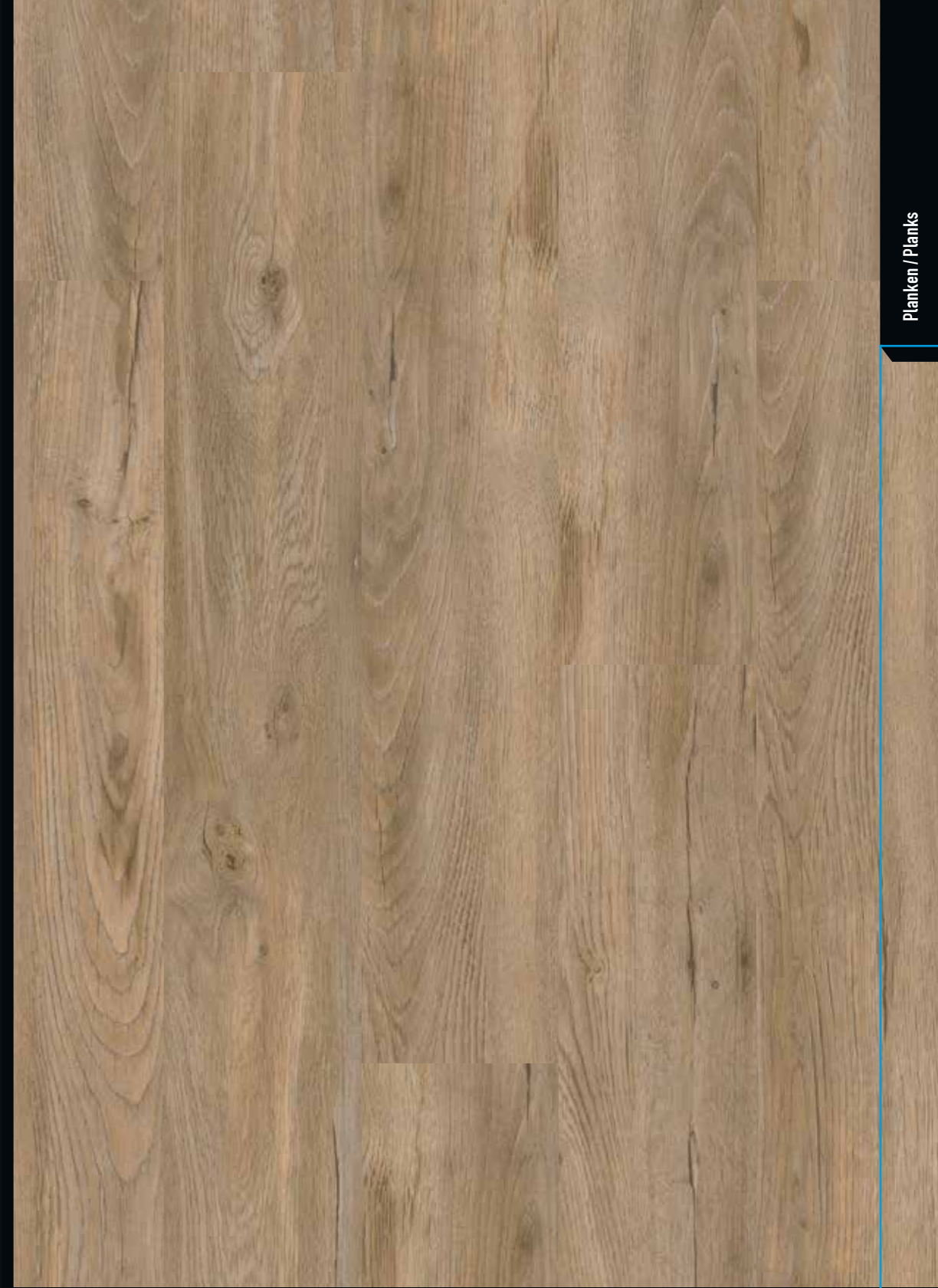

Planken / Planks

PW 2020 -/55



1219 x 183 x 2,5 mm



Mehr zum Dekor!
More about the design!

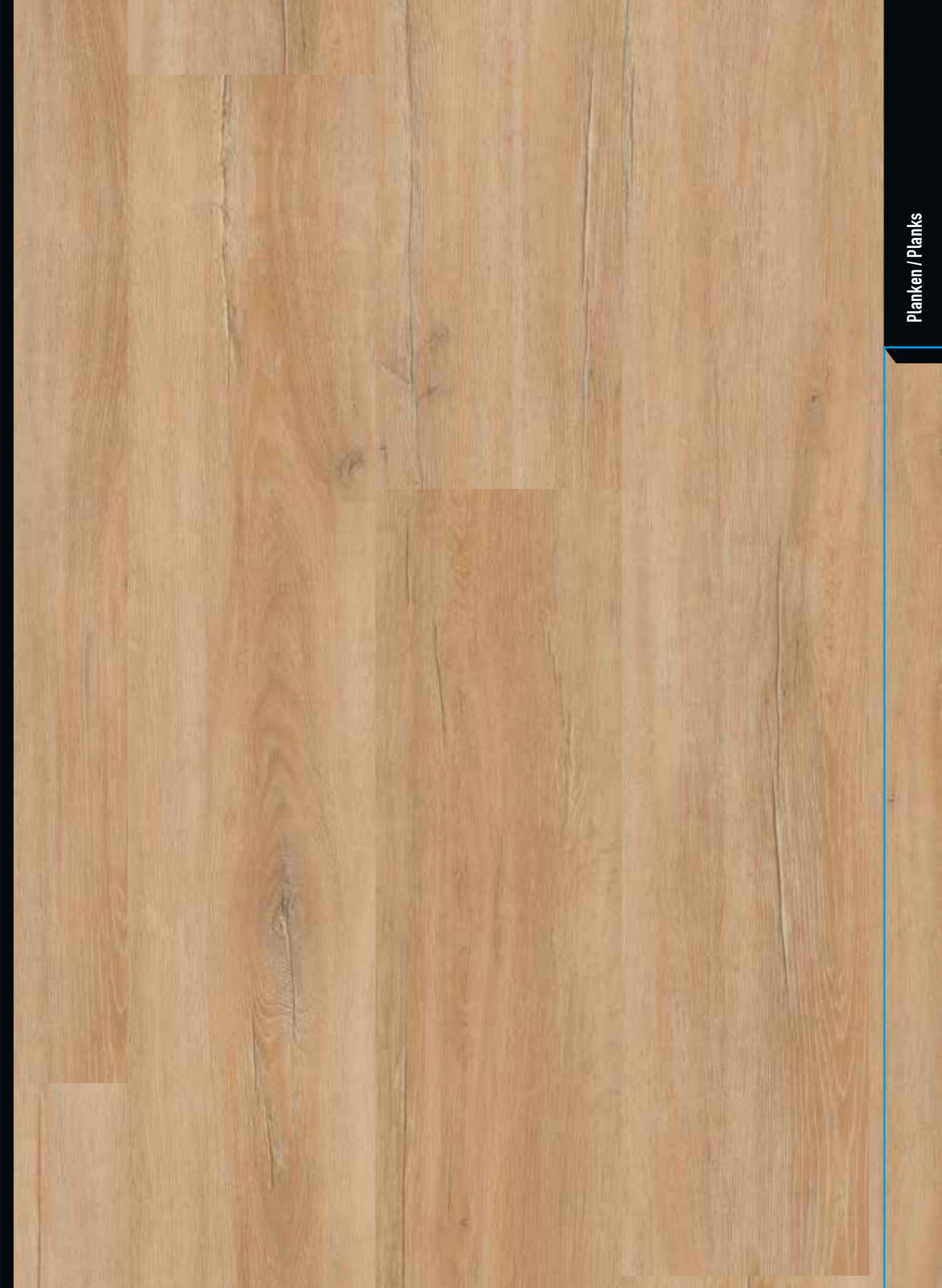

PW 3913 -/55



1219 x 228 x 2,5 mm



Mehr zum Dekor!
More about the design!

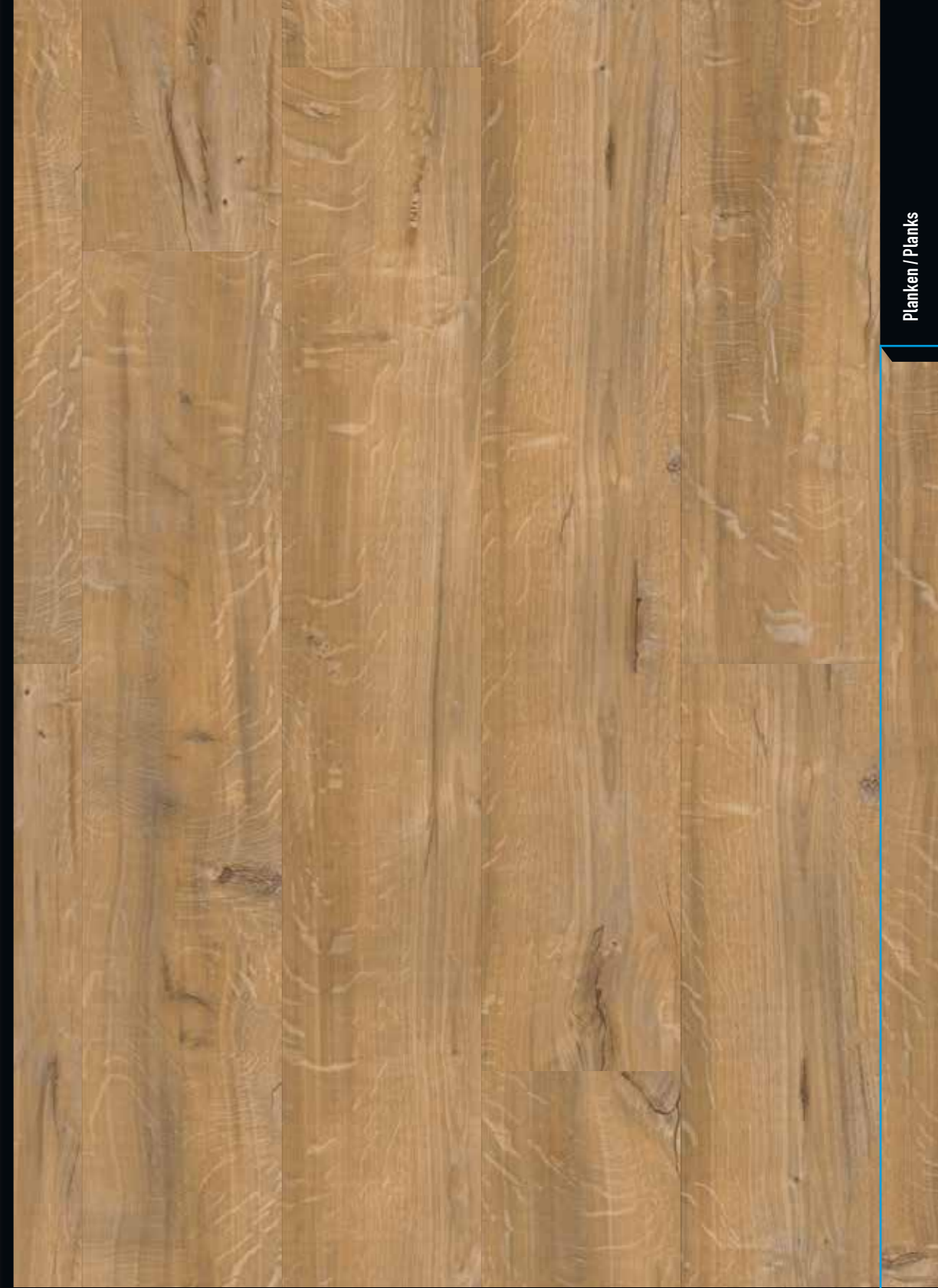

PW 3190 -/55



1219 x 183 x 2,5 mm



Mehr zum Dekor!
More about the design!

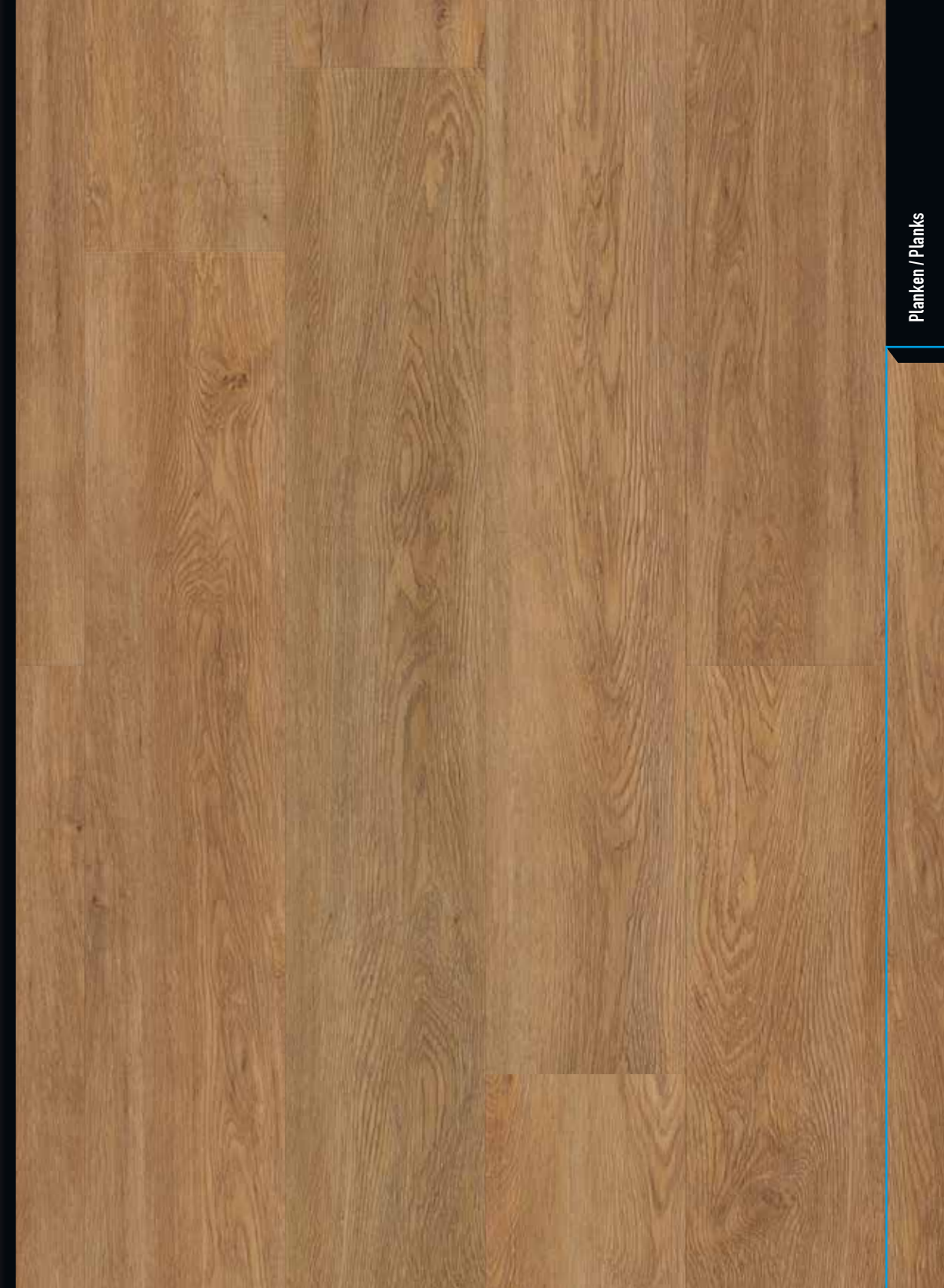

PW 3066 -/55



1219 x 183 x 2,5 mm



Mehr zum Dekor!
More about the design!

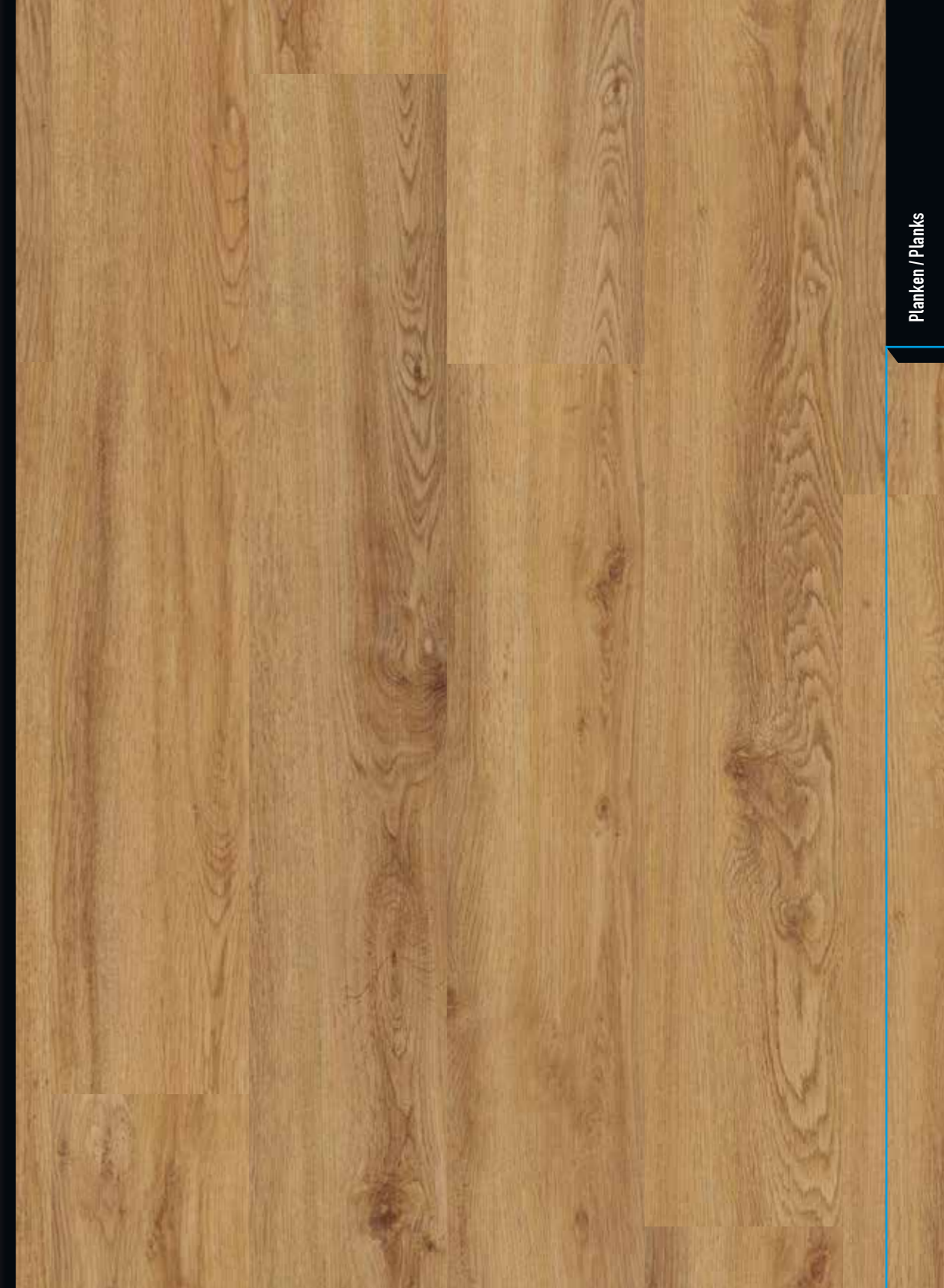

PW 3241 -/55



1219 x 183 x 2,5 mm



Mehr zum Dekor!
More about the design!



RESTAURANT

Boulangerie
Midi

Planken / Planks

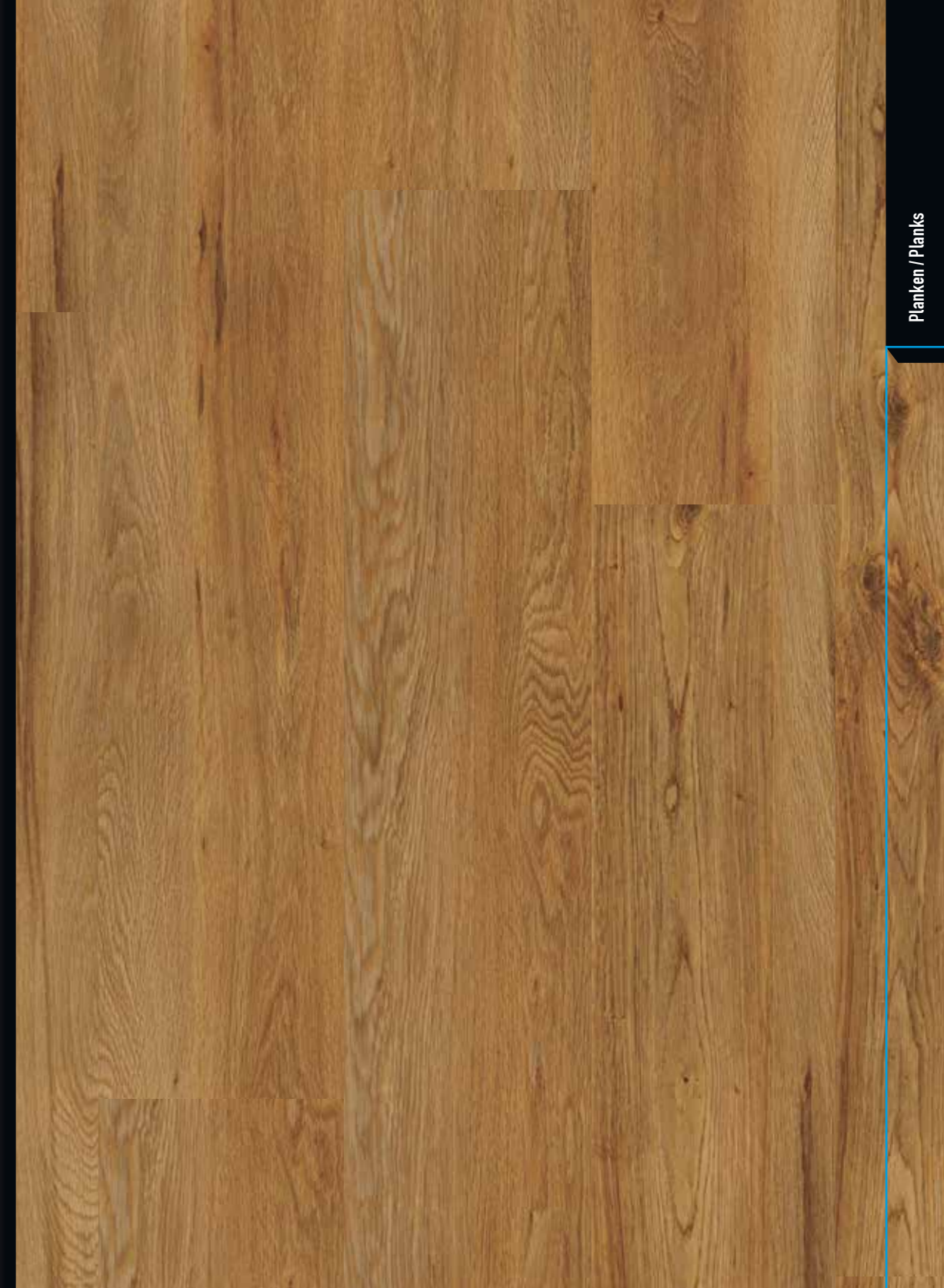

PW 3841 -/55



1219 x 228 x 2,5 mm

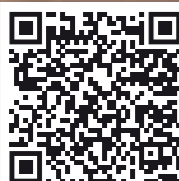

Mehr zum Dekor!
More about the design!

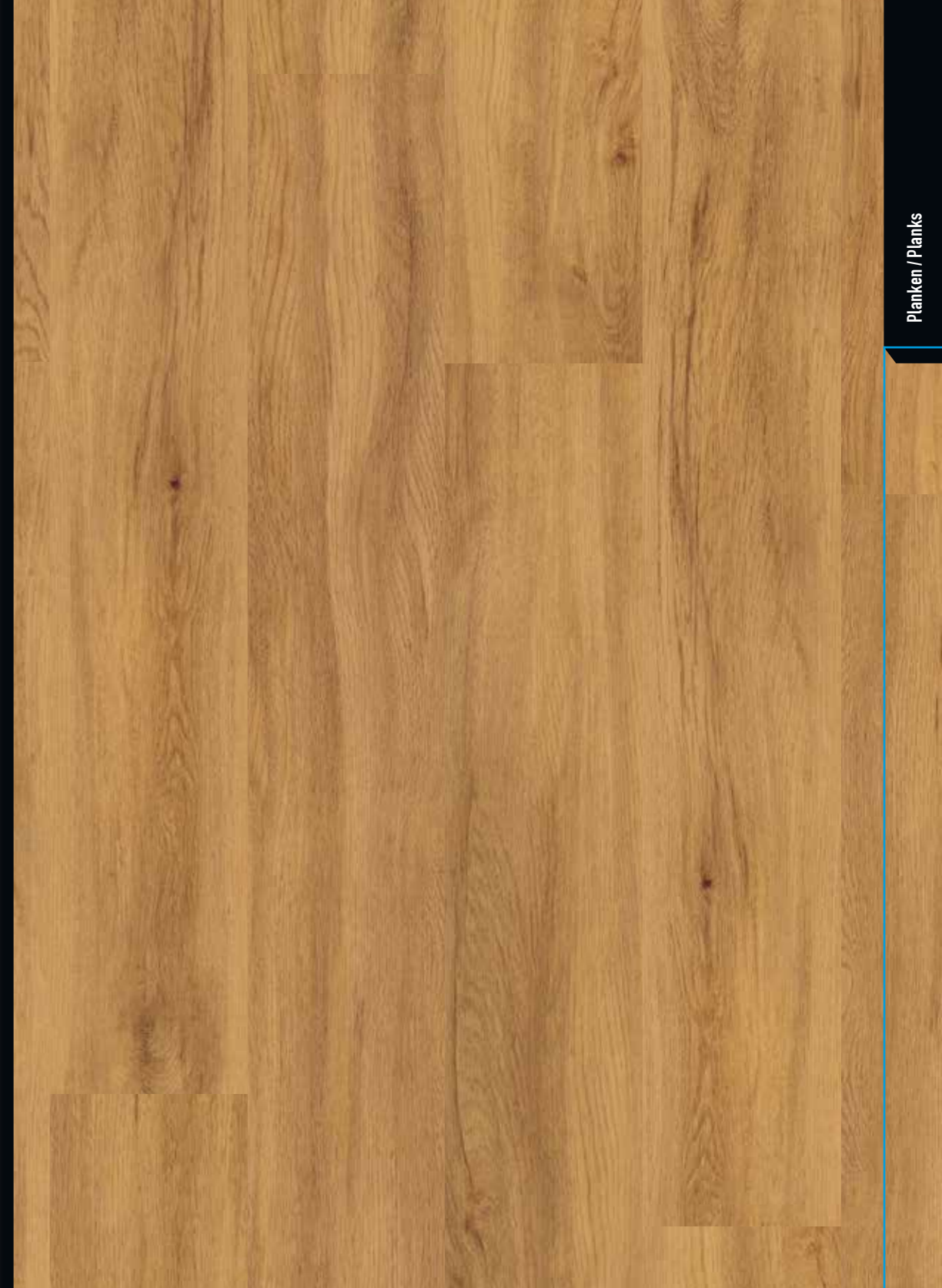

PW 3058 -/55



1219 x 183 x 2,5 mm



Mehr zum Dekor!
More about the design!

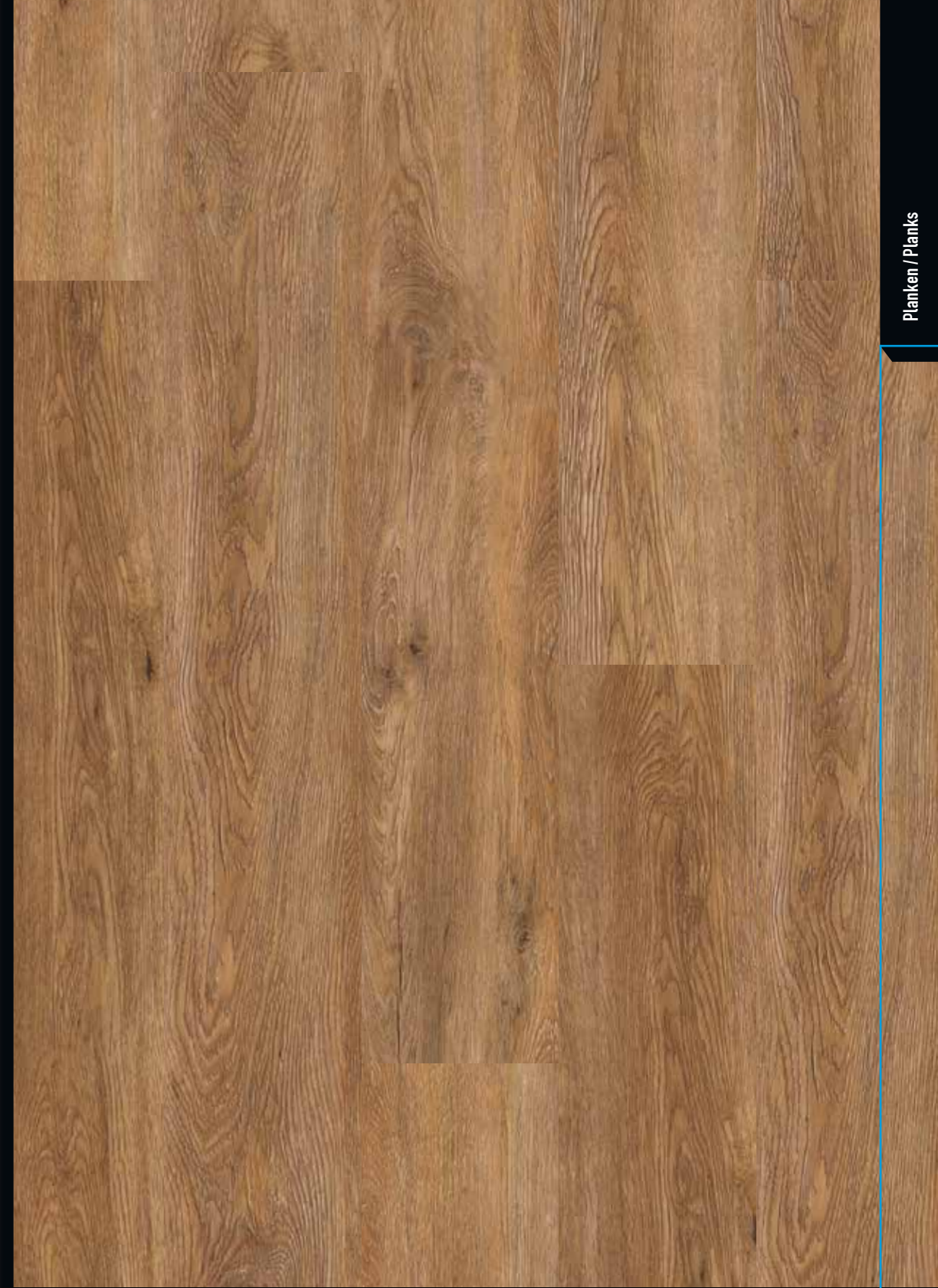

Planken / Planks

PW 3065 -/55



1219 x 183 x 2,5 mm



Mehr zum Dekor!
More about the design!

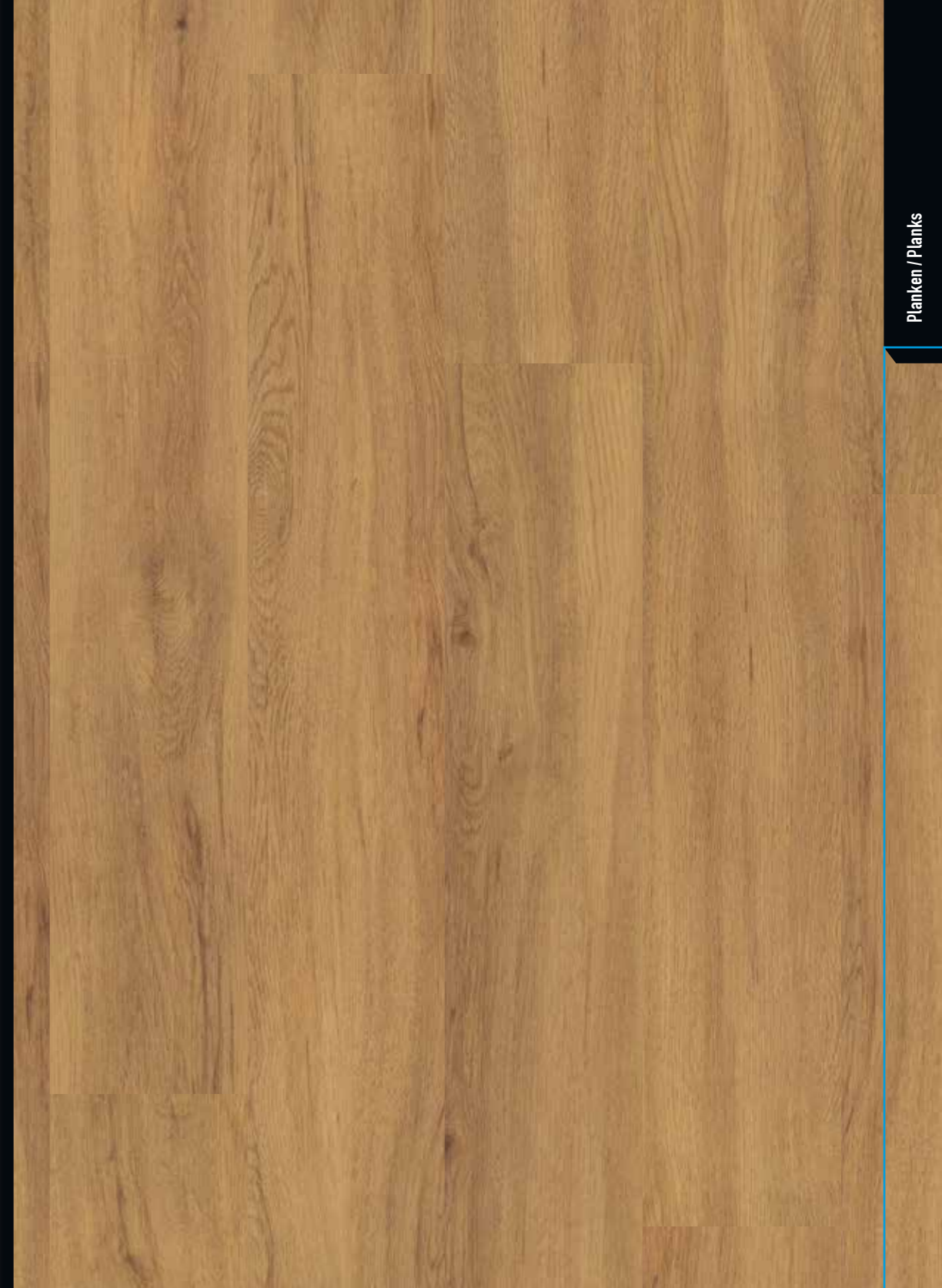
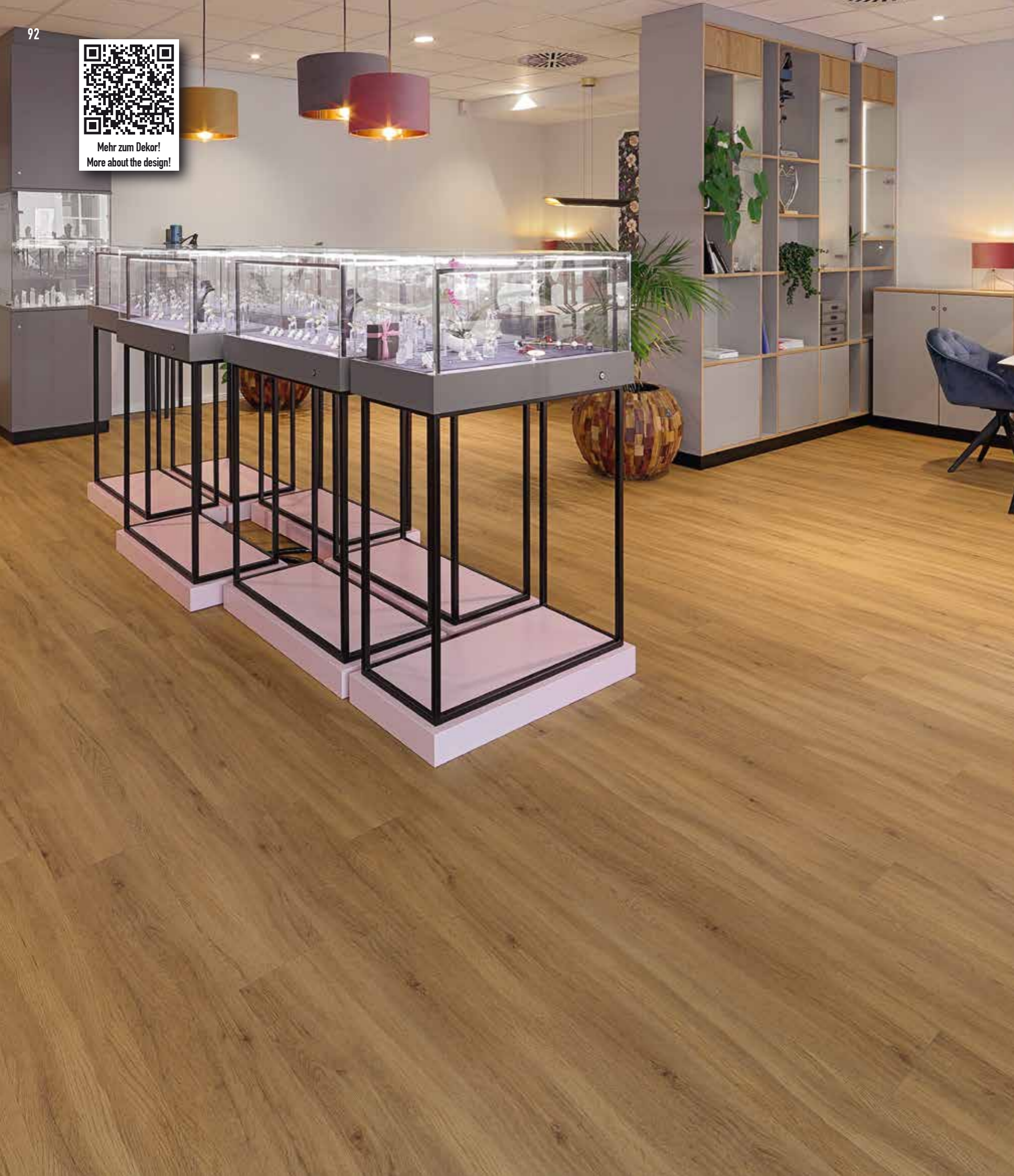

PW 3361 -/55



1219 x 183 x 2,5 mm



Mehr zum Dekor!
More about the design!

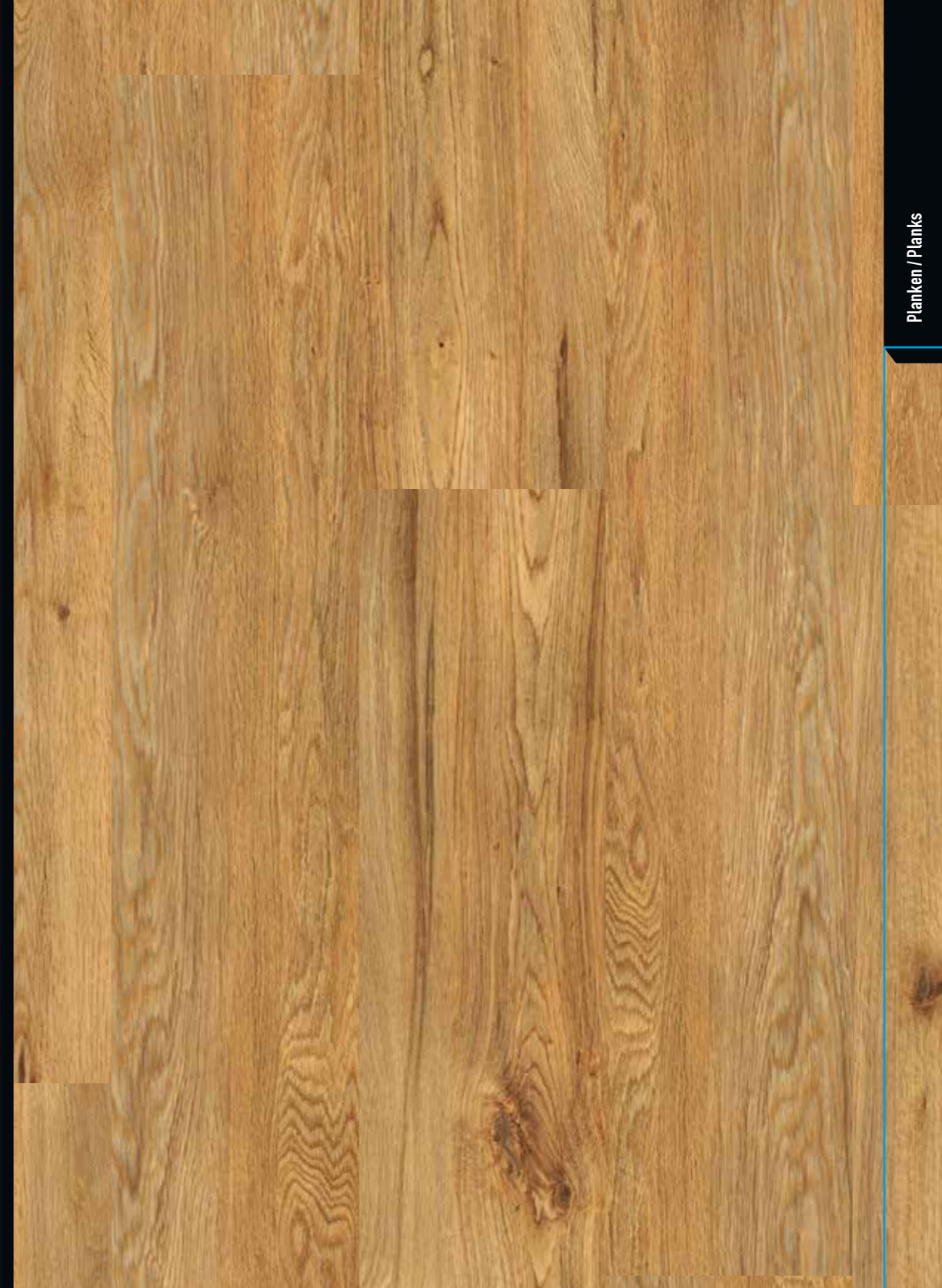



Mehr zum Dekor!
More about the design!



PW 1634 -/55



914 x 152 x 2,5 mm



Mehr zum Dekor!
More about the design!

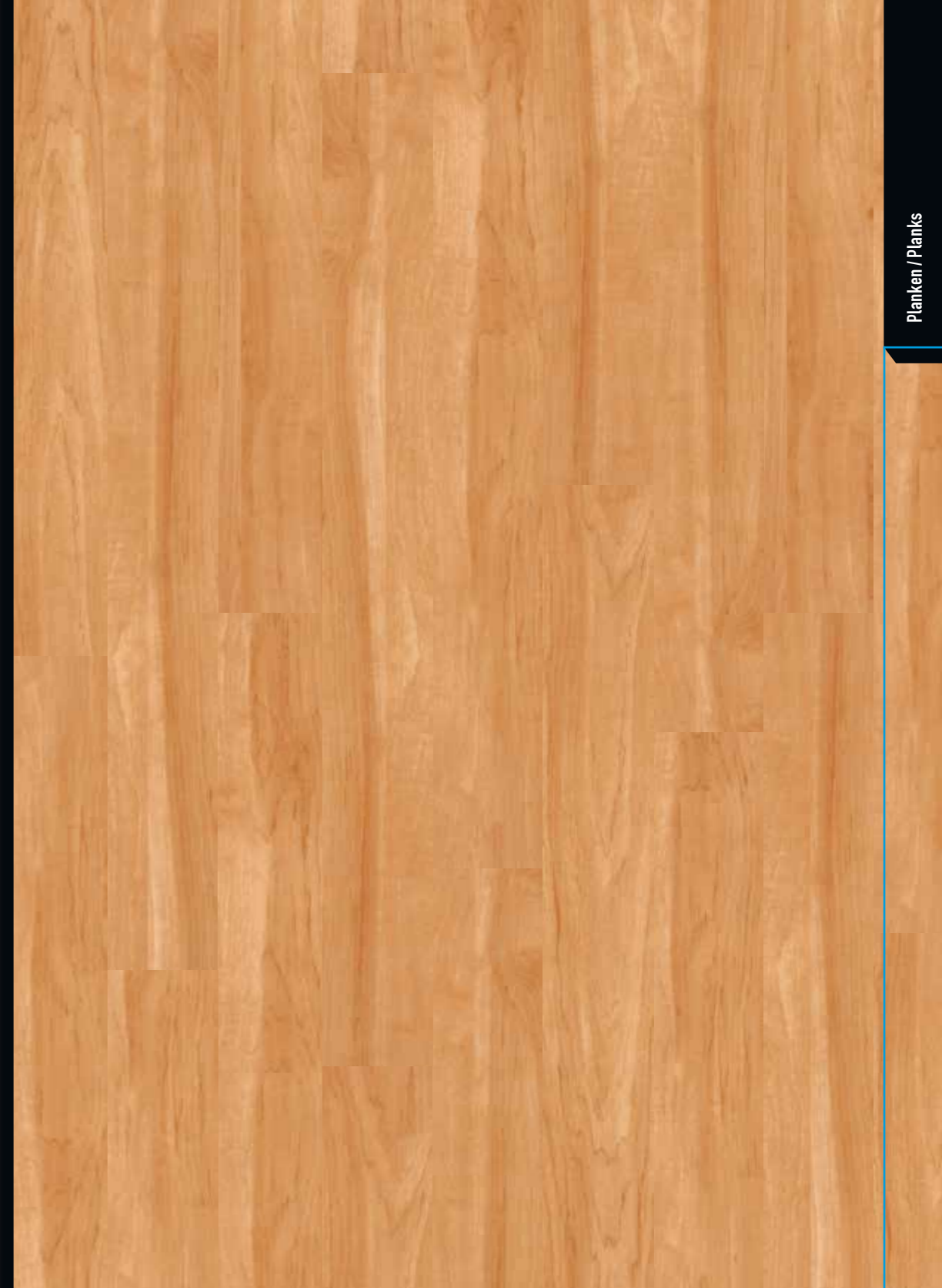

PW 1905 -/55



914 x 102 x 2,5 mm



Mehr zum Dekor!
More about the design!

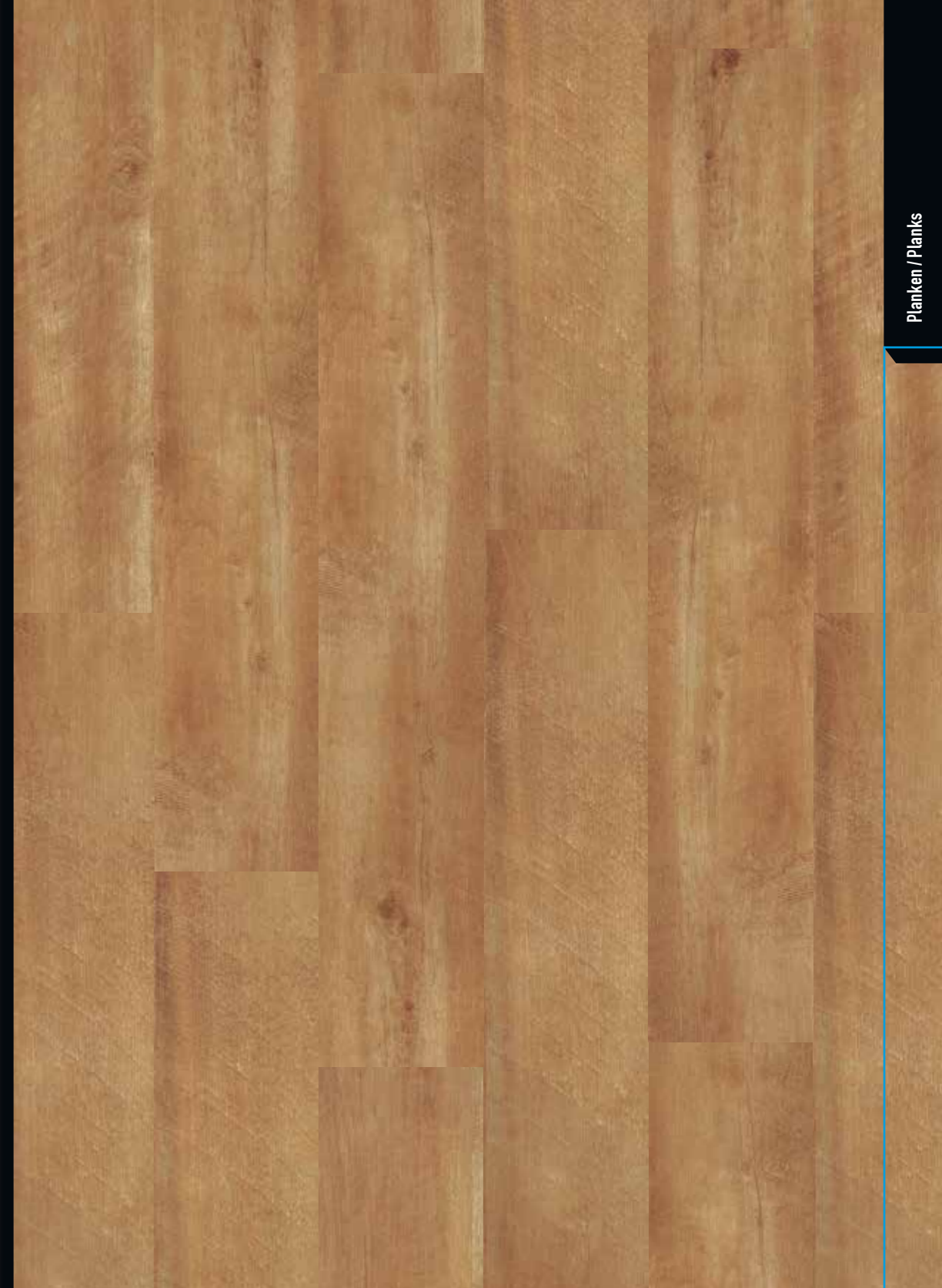

Planken / Planks

Mit optionalen silbergrauen Fugenprofilen
With optional feature strips silver grey

PW 2002 -/55



914 x 152 x 2,5 mm



Mehr zum Dekor!
More about the design!



PW 3820 -/55



1219 x 183 x 2,5 mm



Mehr zum Dekor!
More about the design!



Planken / Planks

PW 3115 -/55



1219 x 183 x 2,5 mm



Mehr zum Dekor!
More about the design!

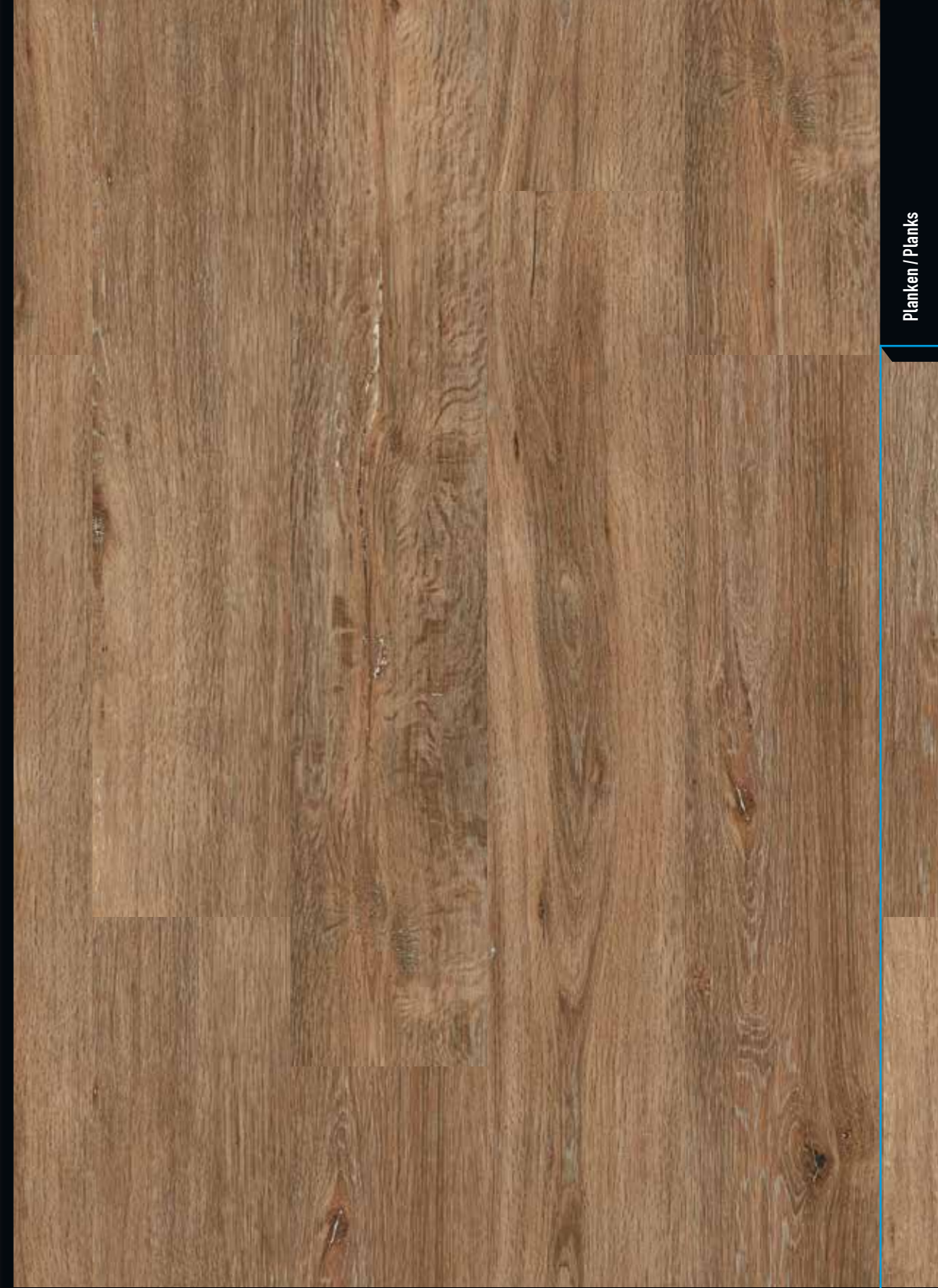

Planken / Planks

PW 3610 -/55



1219 x 183 x 2,5 mm



Mehr zum Dekor!
More about the design!

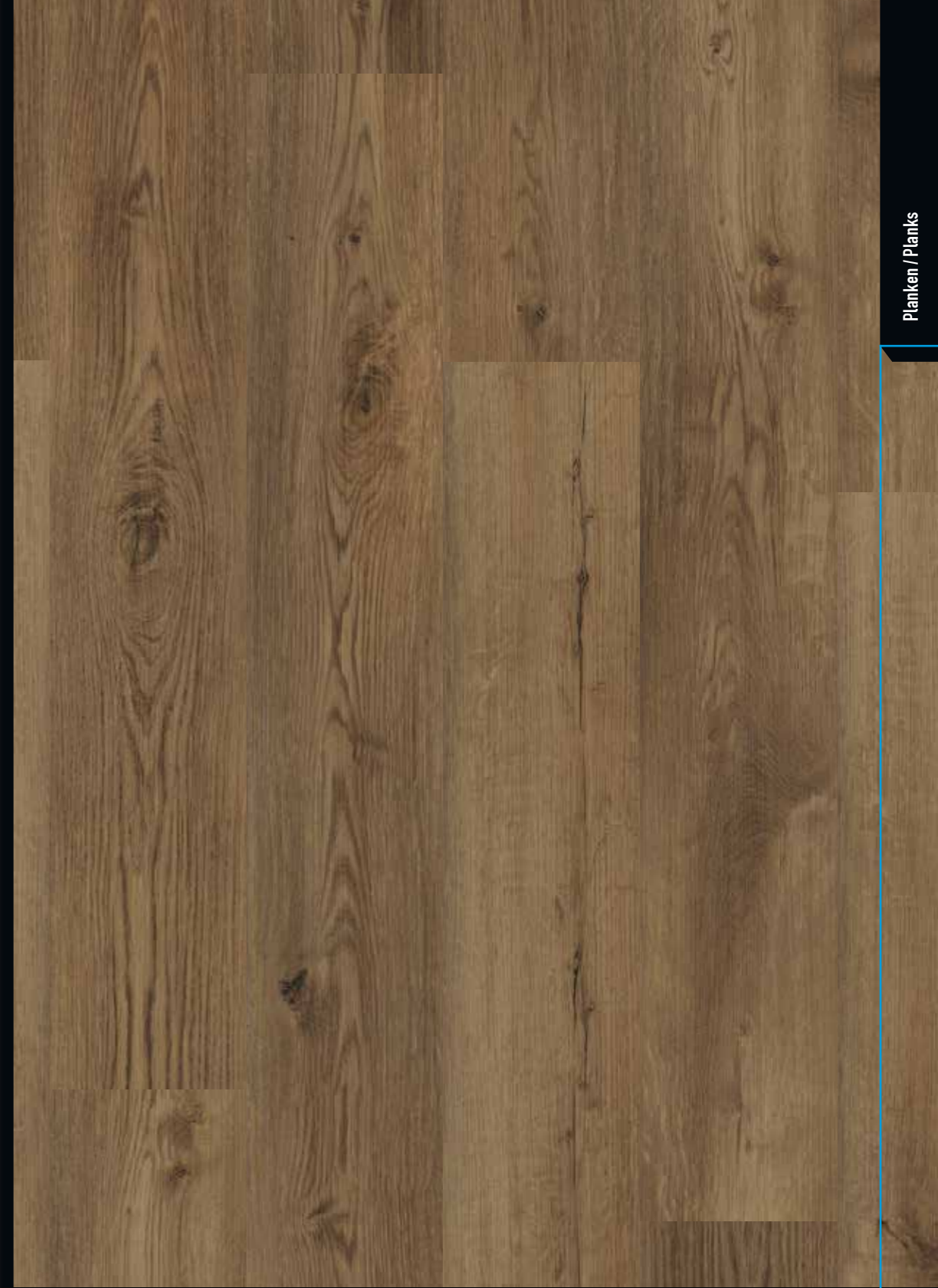

PW 3260 -/55



1219 x 183 x 2,5 mm



Mehr zum Dekor!
More about the design!

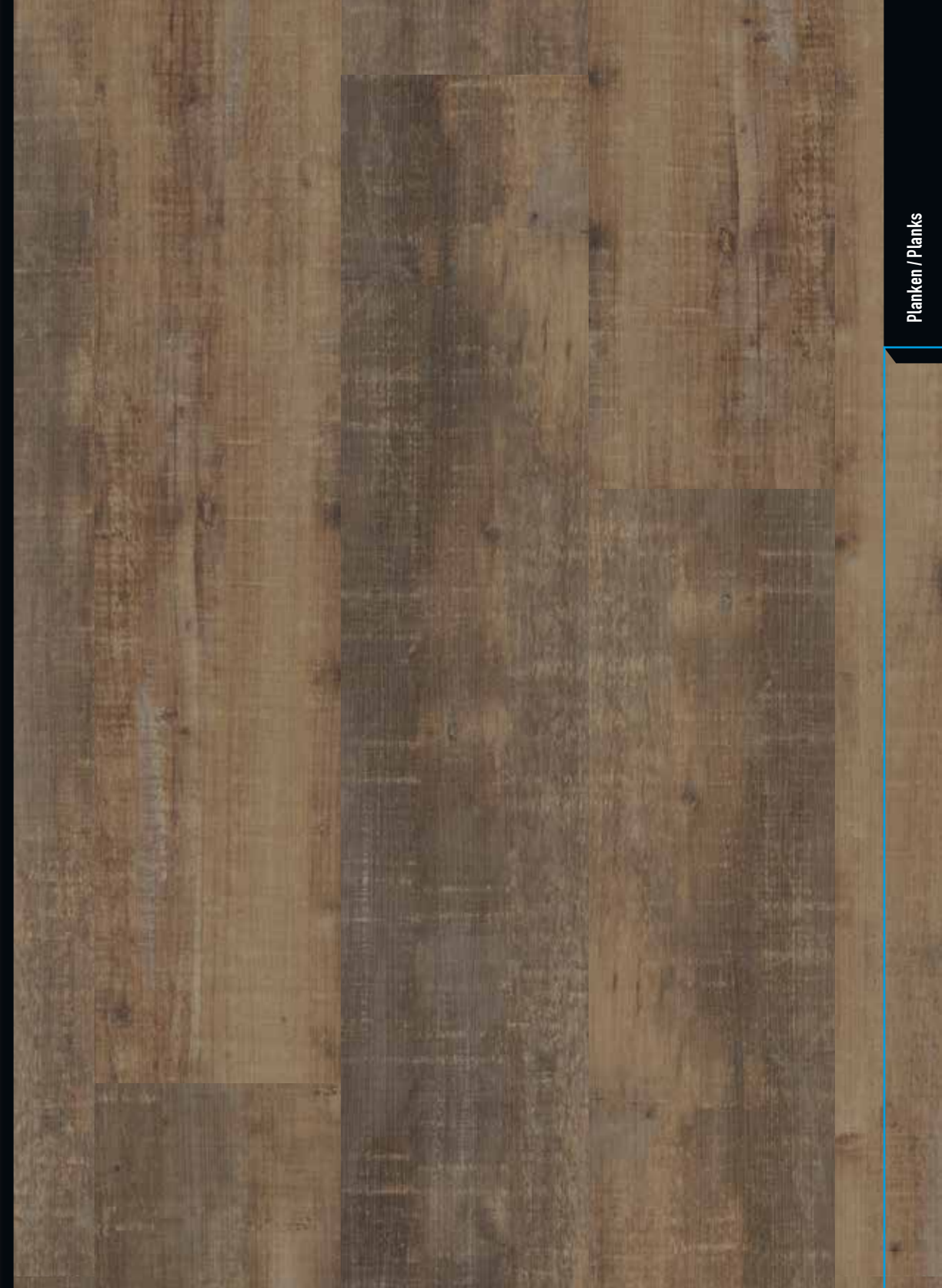

PW 3881 -/55



1219 x 228 x 2,5 mm



Mehr zum Dekor!
More about the design!

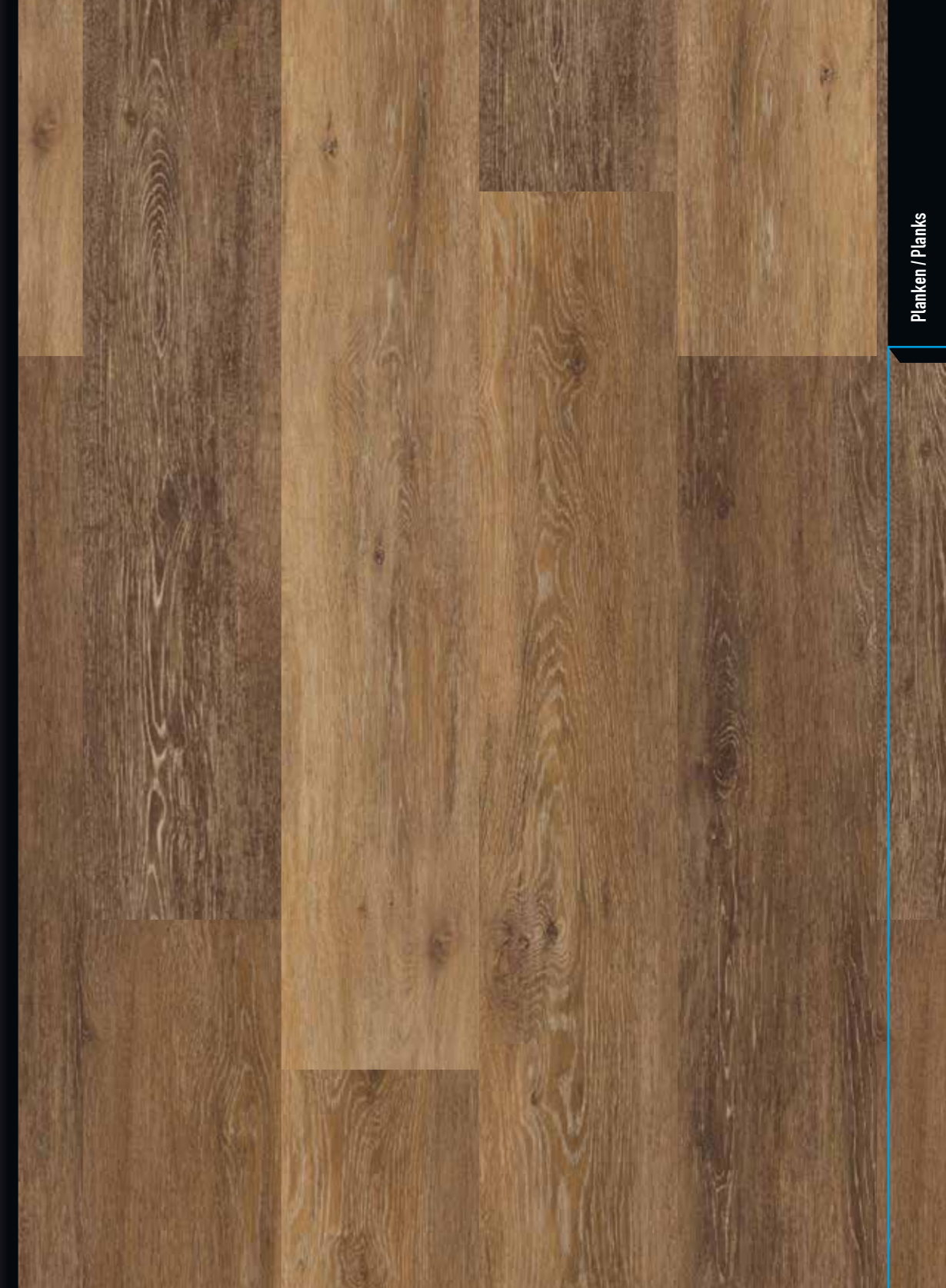

Planken / Planks



PW 1261 -/55



1219 x 183 x 2,5 mm



Mehr zum Dekor!
More about the design!

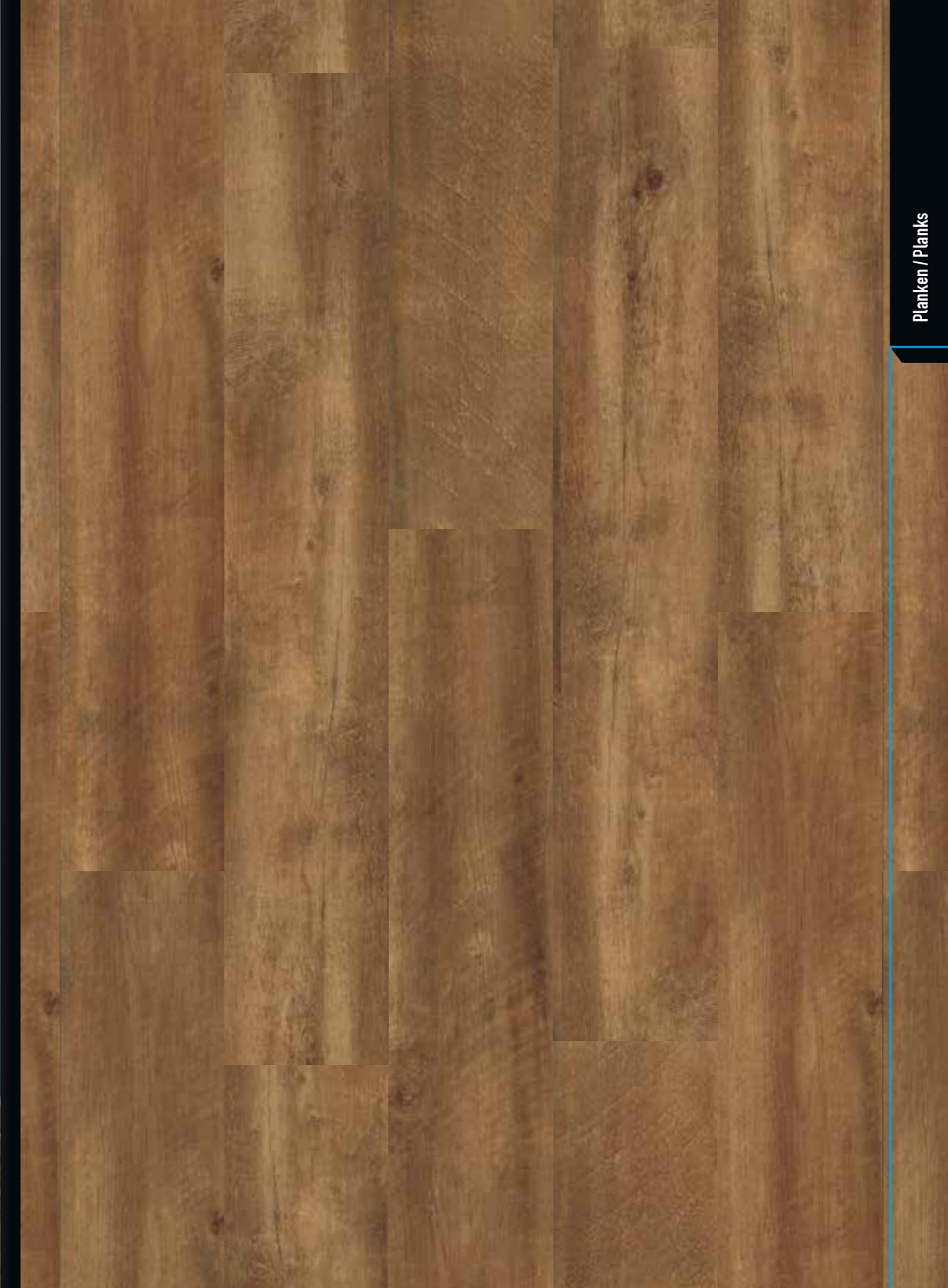

PW 2003 -/55



914 x 152 x 2,5 mm



Mehr zum Dekor!
More about the design!



Planken / Planks

PW 3130 -/55



1219 x 183 x 2,5 mm



Mehr zum Dekor!
More about the design!



Mit optionalen schwarzen Fugenprofilen
With optional feature strips black

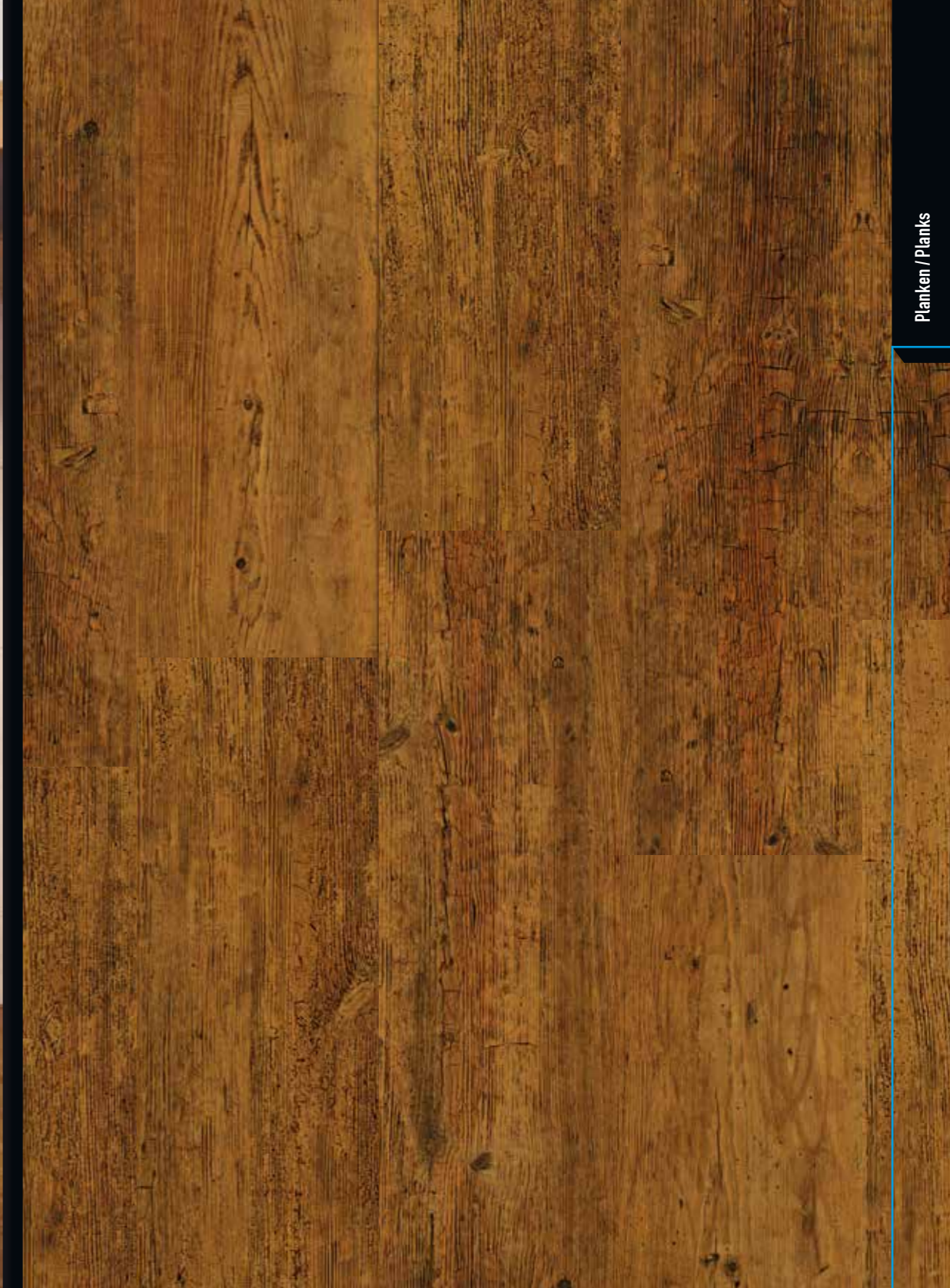

PW 2400 -/55



914 x 228 x 2,5 mm



Mehr zum Dekor!
More about the design!

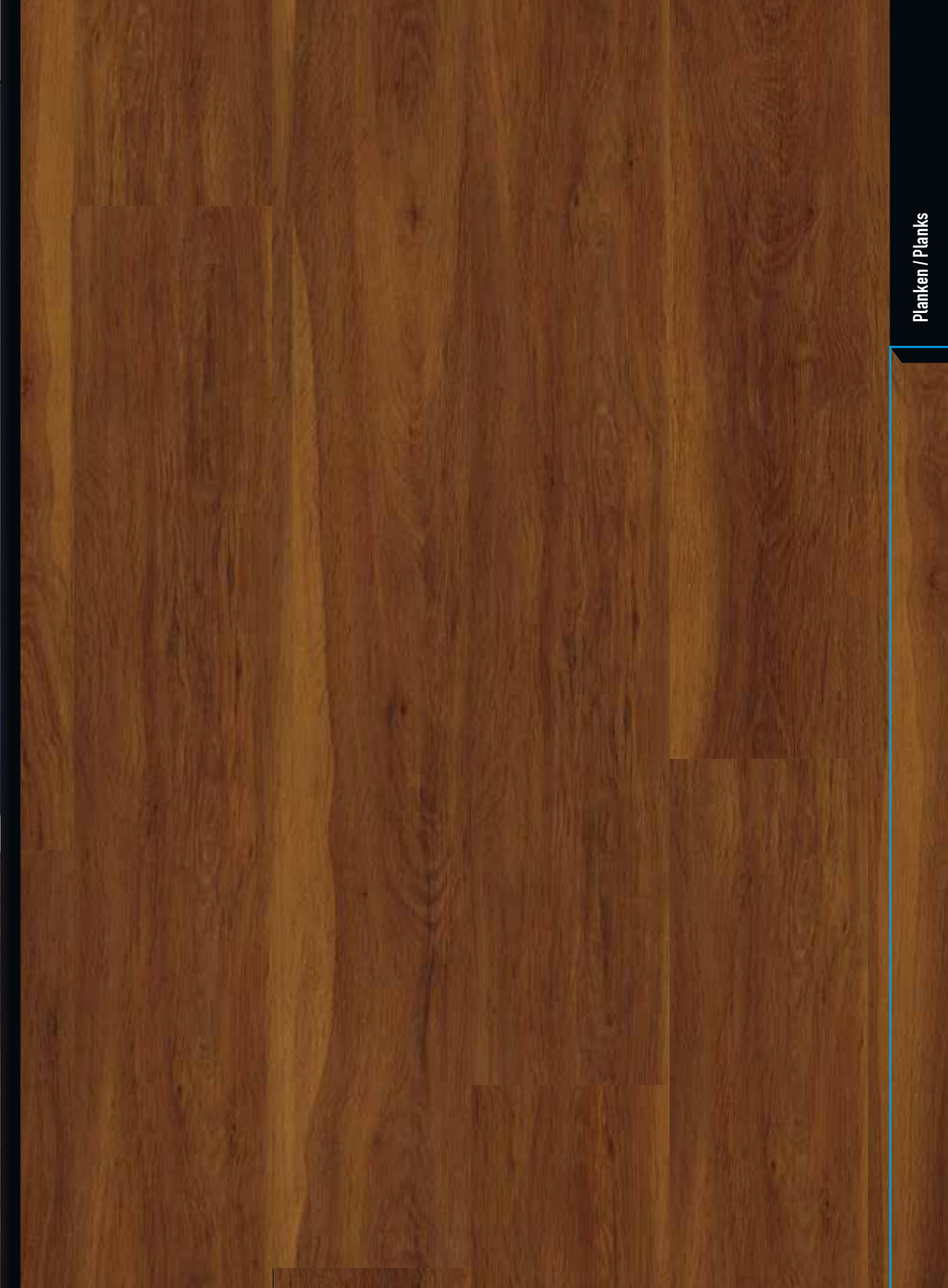

PW 3535 -/55



1219 x 183 x 2,5 mm



Mehr zum Dekor!
More about the design!

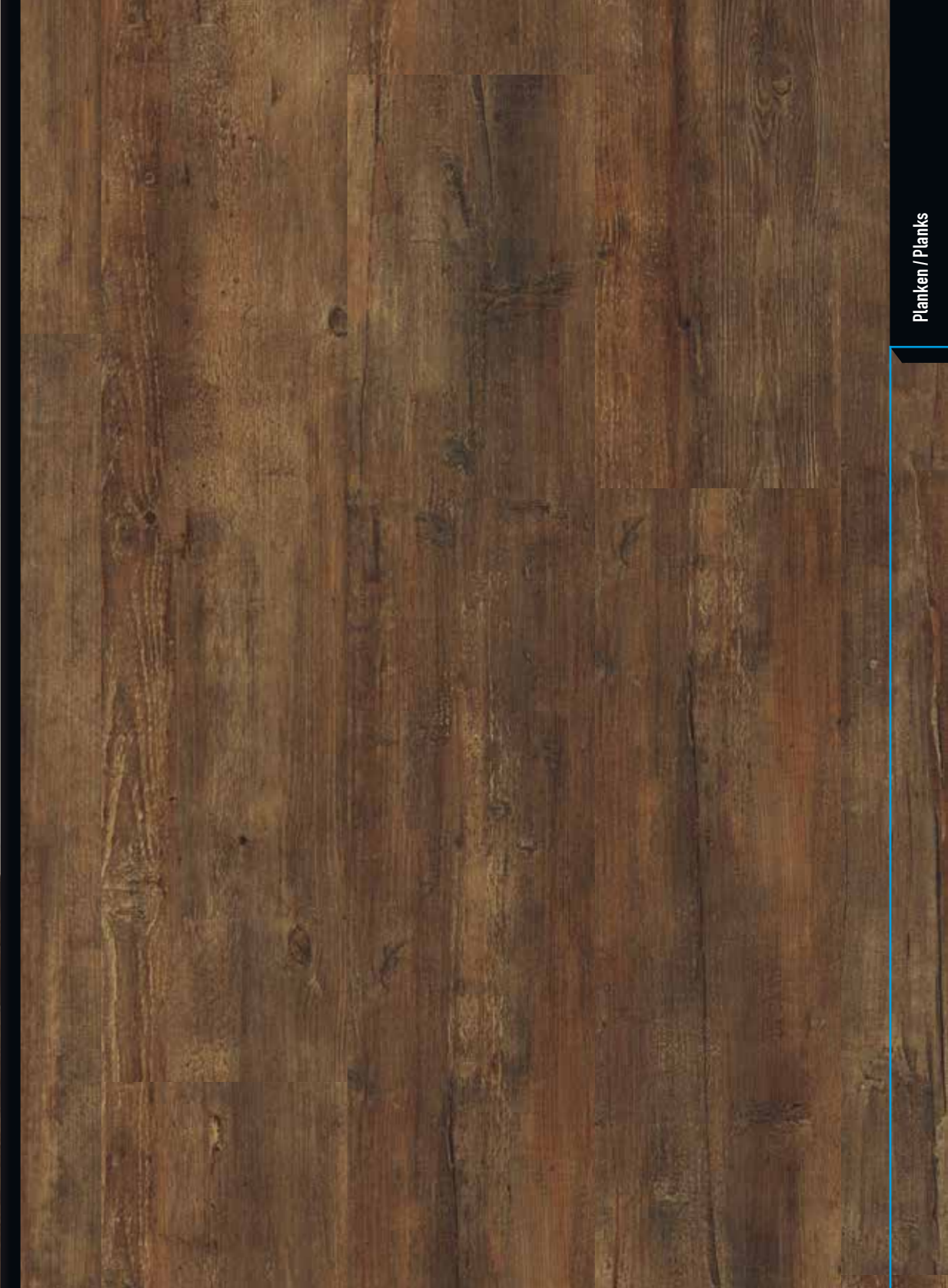

PW 3811 -/55



1219 x 228 x 2,5 mm



Mehr zum Dekor!
More about the design!

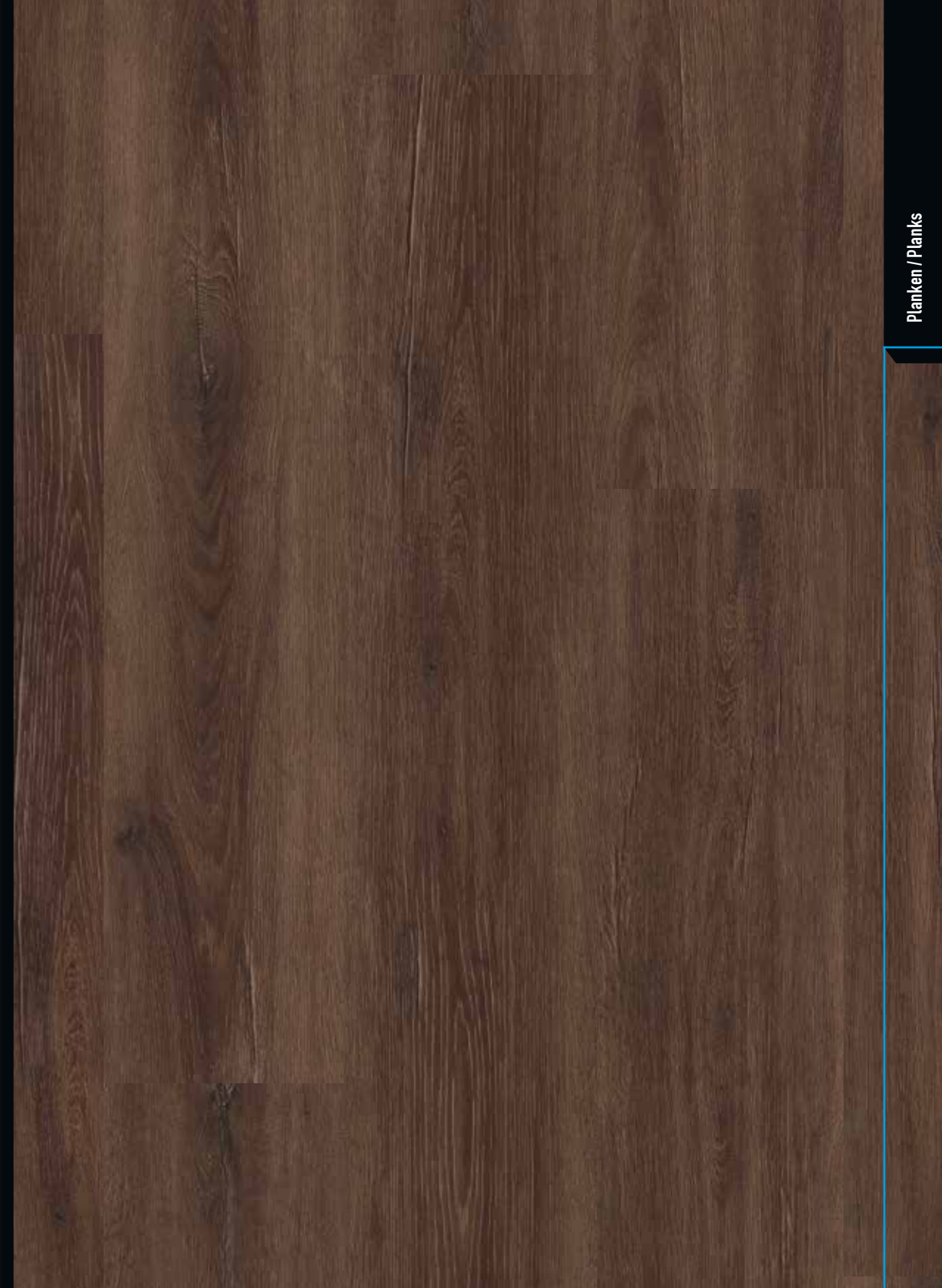

PW 3911 -/55



1219 x 228 x 2,5 mm



Mehr zum Dekor!
More about the design!



PW 3620 -/55



1219 x 183 x 2,5 mm

Designverlegungen Design installations

Designbodenbeläge werden ihrem Namen insbesondere dann gerecht, wenn der Boden eine außergewöhnliche und ausdrucksstarke Gestaltung erhält. Neben den zuvor gezeigten Holzoptiken bietet PROJECT FLOORS Ihnen daher auch eine Auswahl von Dekoren in Sonderformaten an. Das Fischgrät- und das Chevron-Muster sind klassische Varianten aus dem Parkettbereich, um Räumen eine elegante Anmutung zu verleihen und an die Böden alter Herrenhäuser des 17. Jahrhunderts zu erinnern. Das edel wirkende Ergebnis lässt sich hervorragend sowohl mit antiken als auch mit modernen Möbeln kombinieren und ist in allen Objektbereichen als Neuinterpretation des traditionellen Holzbodens eine aufmerksamerke Bodengestaltung.

Design floor coverings really live up to their name when the floor is installed in an extraordinary and expressive manner. In addition to the wood designs displayed on the previous pages, PROJECT FLOORS also offers a choice of special sized planks. The Herringbone and Chevron plank formats are classic variations of hardwood flooring that provide rooms with an elegant appearance reminiscent of flooring from the grand homes of the 17th century. These stylish and timeless designs are as equally at home when combined with antique furniture as they are when incorporated into a modern interior design. Our Herringbone and Chevron designs are an eye-catching reinterpretation of traditional hardwood floors, suitable for use in all commercial areas.



Mehr zum Design!
More about the design!



Fischgrät-Verlegung / Herringbone installation, PW 3065/HB



Mehr zum Design!
More about the design!

Chevron-Verlegung / Chevron installation, PW 3130/FP



Mehr zum Design!
More about the design!

Fischgrät-Verlegung / Herringbone installation, PW 3350/HBL

Fischgrät Herringbone

Zehn Dekore in den Sondermaßen 457 x 76 x 2,5 mm und 610 x 102 x 2,5 mm machen diese Verlegeart einfach realisierbar. Die rundum gefasteten Elemente bieten aber auch weitere Möglichkeiten für eine ansprechende und individuelle Innenarchitektur, wie z.B. die Holzblock- oder Leiterbodenverlegung (siehe Seite 225). Die zehn Dekore der Fischgrät-Planken sind mit einer Nutzschicht von 0,55 mm erhältlich.

PROJECT FLOORS offers ten planks in the special sizes of 457 x 76 x 2,5 mm and 610 x 102 x 2,5 mm to allow an easy implementation of this installation format. The planks, with bevelled edges on all sides, can also be used for other installation formats, like woodblock or ladder pattern (see page 225), to create an appealing and individual interior design. The ten designs of the Herringbone Collection are available with a 0.55 mm wear layer.

/HB

457 x 76 mm

0,55 mm Nutzschicht
0.55 mm wear layer

2,5 mm Gesamtstärke
2.5 mm total thickness

angefaste Kanten
bevelled edges

/HBL

610 x 102 mm

0,55 mm Nutzschicht
0.55 mm wear layer

2,5 mm Gesamtstärke
2.5 mm total thickness

angefaste Kanten
bevelled edges



Als Fischgrät-Planken erhältliche Dekore sind mit diesem Symbol gekennzeichnet.

Designs available as herringbone planks are marked with this symbol.

PW 1255/HB

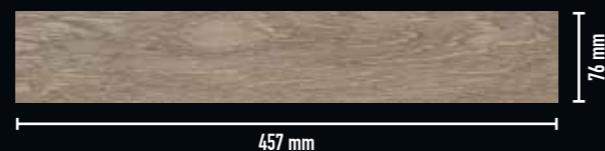

PW 1265/HB



PW 1633/HB



PW 3350/HB



PW 3066/HB



PW 3840/HB



PW 3610/HB



PW 3065/HB



PW 1261/HB



PW 3535/HB



PW 1255/HBL



PW 1265/HBL



PW 1633/HBL



PW 3350/HBL



PW 3066/HBL



PW 3840/HBL

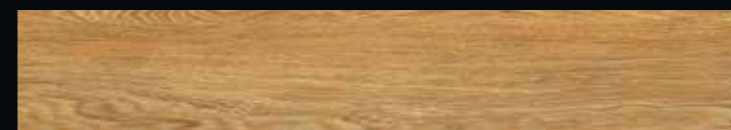

PW 3610/HBL



PW 3065/HBL



PW 1261/HBL



PW 3535/HBL



Mehr zum Design!
More about the design!



PW 1255/HB

457 x 76 x 2.5 mm



PW 1255/HBL

610 x 102 x 2.5 mm



PW 3350/HB

457 x 76 x 2.5 mm



PW 3350/HBL

610 x 102 x 2.5 mm



PW 1265/HB

457 x 76 x 2.5 mm



PW 1265/HBL

610 x 102 x 2.5 mm



PW 3066/HB

457 x 76 x 2.5 mm



PW 3066/HBL

610 x 102 x 2.5 mm



PW 1633/HB

457 x 76 x 2.5 mm



PW 1633/HBL

610 x 102 x 2.5 mm



PW 3840/HB

457 x 76 x 2.5 mm



PW 3840/HBL

610 x 102 x 2.5 mm



PW 3610/HB

457 x 76 x 2.5 mm



PW 3610/HBL

610 x 102 x 2.5 mm



PW 3535/HB

457 x 76 x 2.5 mm



PW 3535/HBL

610 x 102 x 2.5 mm



PW 3065/HB

457 x 76 x 2.5 mm



PW 3065/HBL

610 x 102 x 2.5 mm



PW 1261/HB

457 x 76 x 2.5 mm



PW 1261/HBL

610 x 102 x 2.5 mm



PW 3610/HB

Chevron

Acht Dekore im Chevron Format, die in einem Winkel von 60 Grad abgeschrägt sind, ermöglichen eine geschmackvolle Gestaltungsvariante. Diese auch „Französisches Parkett“ genannte Verlegeart wird mit Planken im Sondermaß 457 x 102 x 2,5 mm möglich. Alle Dekore sind mit einer Nutzschicht von 0,55 mm erhältlich und rundum gefast.

Eight designs are available in the Chevron cut, also known as "French Parquet" format. The 60 degree angle of the planks allows them to be arranged in this aesthetically pleasing design. The planks are cut in the special size of 457 x 102 x 2.5 mm. All designs have a 0.55 mm wear layer and bevelled edges on all sides.



Ergometer
 Geräte
 Hanteln
 Balance
 Warm-up
 Pilates
 Fatburner
 Trainingsplan
 Sauna
 Wellness
 Ernährung
 Laufband
 Faszien
 Rückenschule
 Spinning
 Yoga
 Crosstrainer
 Body-Forming
 Bauch Beine Po



Mehr zum Design!
More about the design!

/FP

0,55 mm Nutzschicht
0,55 mm wear layer

2,5 mm Gesamtstärke
2,5 mm total thickness

angefaste Kanten
bevelled edges



Als Chevron-Planken erhältliche Dekore sind mit diesem Symbol gekennzeichnet.

Designs available as Chevron planks are marked with this symbol.



PW 3100/FP 457 x 102 x 2,5 mm



PW 3220/FP 457 x 102 x 2,5 mm



PW 3130/FP 457 x 102 x 2,5 mm



PW 3535/FP 457 x 102 x 2,5 mm



PW 1633/FP 457 x 102 x 2,5 mm



PW 3350/FP 457 x 102 x 2,5 mm



PW 3840/FP 457 x 102 x 2,5 mm



PW 3065/FP 457 x 102 x 2,5 mm



Mehr zum Design!
More about the design!

PW 3535/FP

Übersicht Planken / Overview planks 914 mm



Übersicht Planken / Overview planks 1219 mm



Übersicht Planken / Overview planks 1219 mm

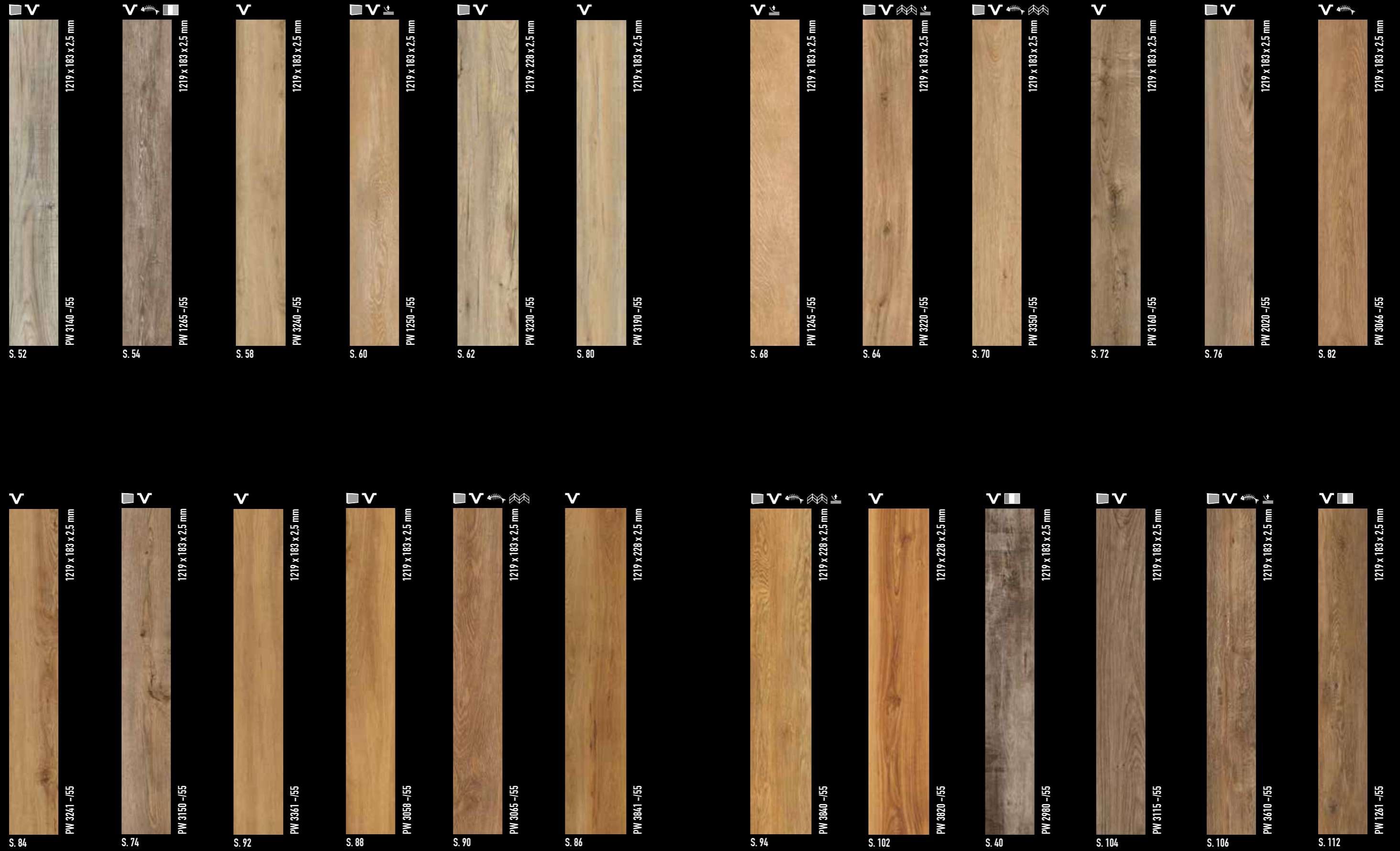

Übersicht Planken / Overview planks 1219 mm



Mehr zum Design!
More about the design!



MA 300 /-55	180
MA 310 /-55	182
SL 306 /-55	178
SL 307 /-55	176
ST 225 /-55	192
ST 400 /-55	184
ST 450 /-55	170
ST 480 /-55	168
ST 750 /-55	200
ST 760 /-55	172
ST 761 /-55	174
ST 920 /-55	166
ST 940 /-55	186
ST 941 /-55	188
ST 945 /-55	194
ST 950 /-55	190
ST 955 /-55	196
ST 956 /-55	198
TR 420 /-55	162
TR 556 /-55	164
TR 715 /-55	148
TR 720 /-55	150
TR 725 /-55	152
TR 730 /-55	154
TR 740 /-55	156
TR 990 /-55	158
TR 991 /-55	160

/55

0,55 mm Nutzschrift
0.55 mm wear layer
2,5 mm Gesamtstärke
2.5 mm total thickness



Diese Dekore werden mit
angefaster Kante geliefert.

These designs will be
delivered with bevelled edges.

SYNC

Diese Dekore haben eine
Synchronprägung.

These designs have a
registered emboss.



Auch erhältlich in der
LOOSE-LAY COLLECTION.

Also available in the
LOOSE-LAY COLLECTION.

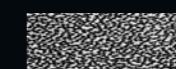

Bitte beachten Sie, dass die
Abbildung der Prägung einen stark
vergrößerten Ausschnitt darstellt
und das Gesamtbild auf der Fliese
von Charge zu Charge abweichen
kann.

Please note that the image of the
embossing represents a greatly
enlarged section and the overall
image on the tile may vary from
batch to batch.



Mehr zum Dekor!
More about the design!



TR 715 -/55



914 x 457 x 2,5 mm



Mehr zum Dekor!
More about the design!



Mit optionalen silbergrauen Fugenprofilen
With optional feature strips silver grey

TR 720 -/55



914 x 457 x 2,5 mm



Mehr zum Dekor!
More about the design!

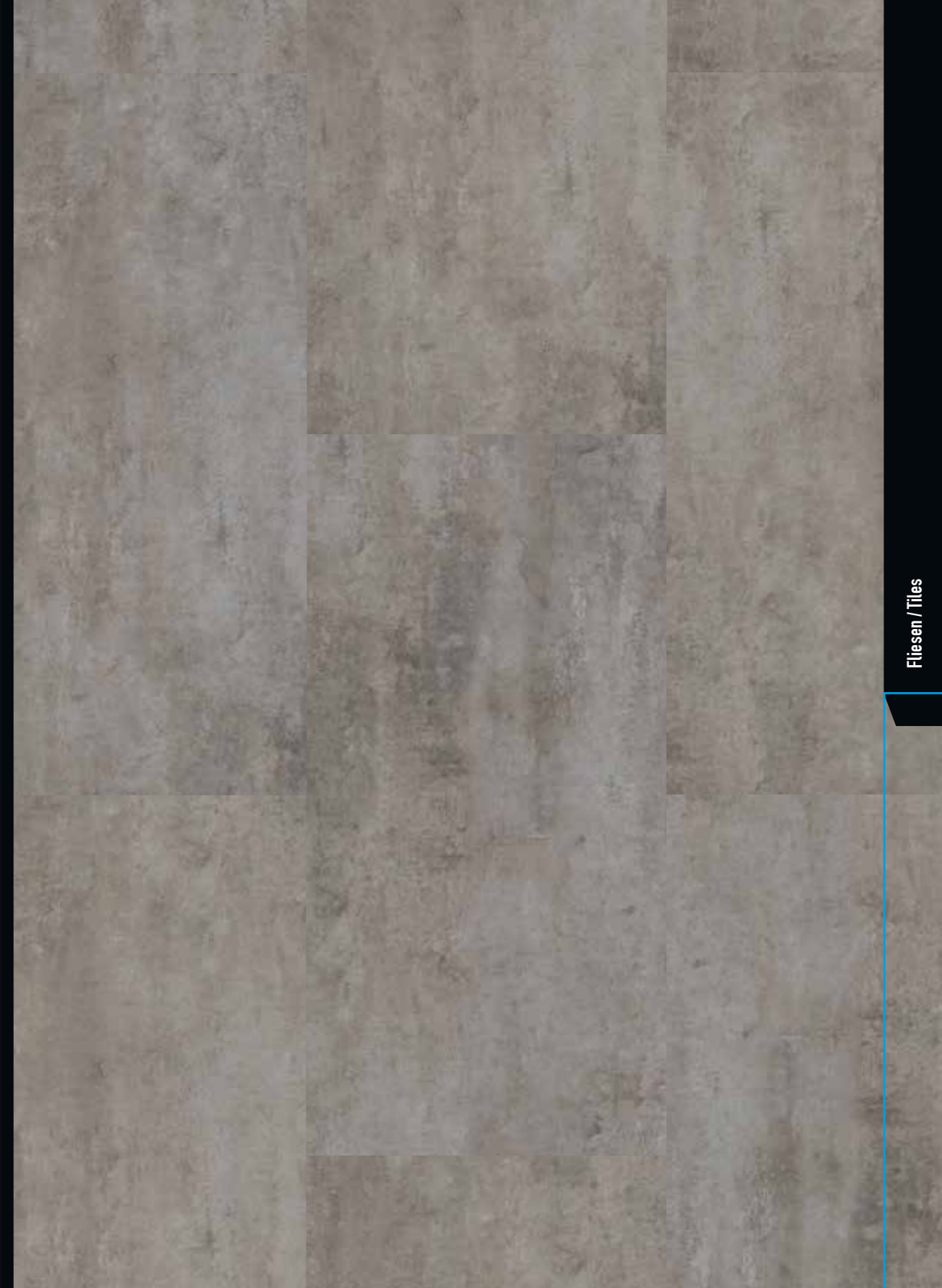

TR 725 -/55



914 x 457 x 2,5 mm



Mehr zum Dekor!
More about the design!

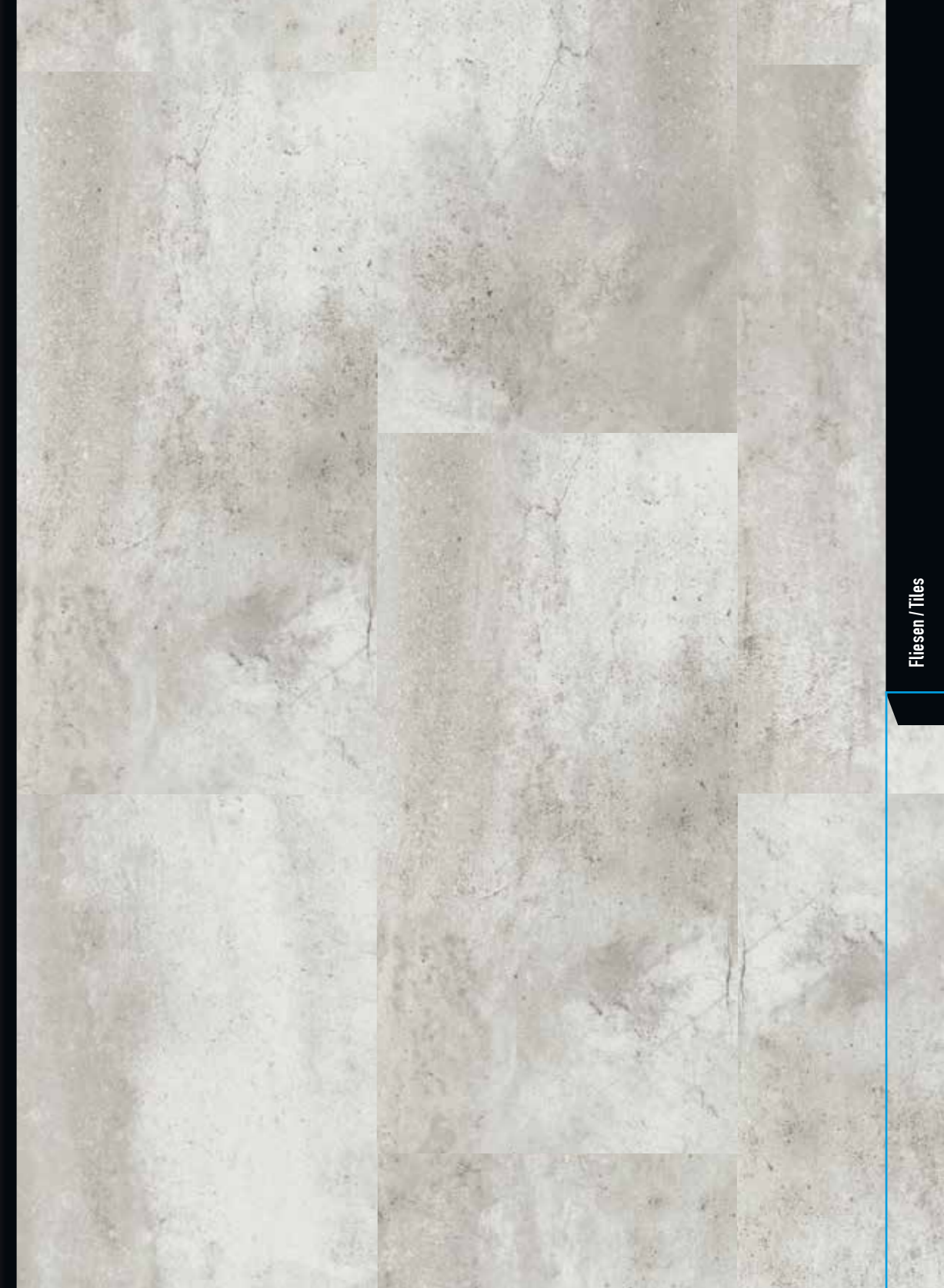

TR 730 -/55



914 x 457 x 2,5 mm



Mehr zum Dekor!
More about the design!

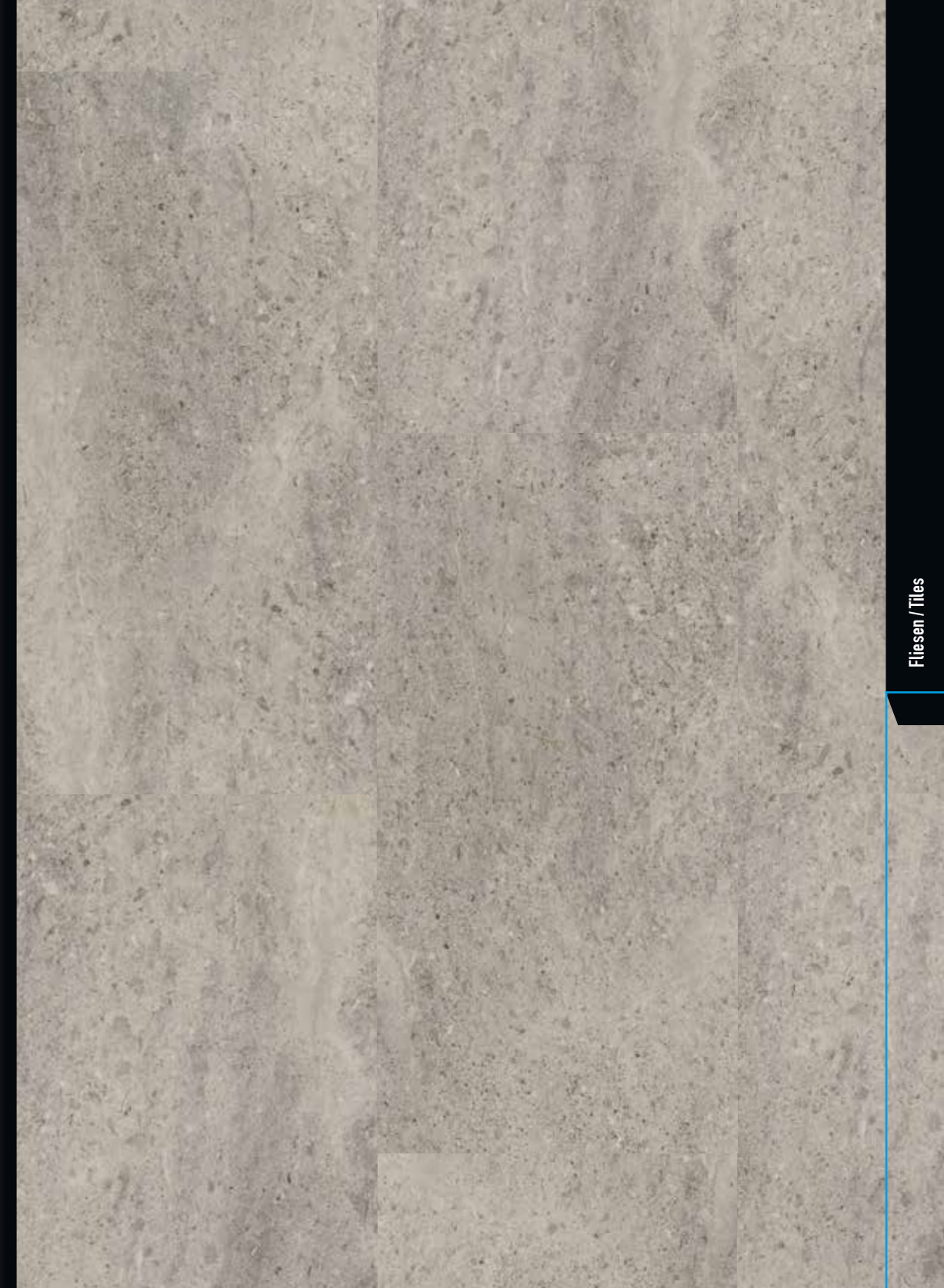

TR 740 -/55



914 x 457 x 2,5 mm



Mehr zum Dekor!
More about the design!

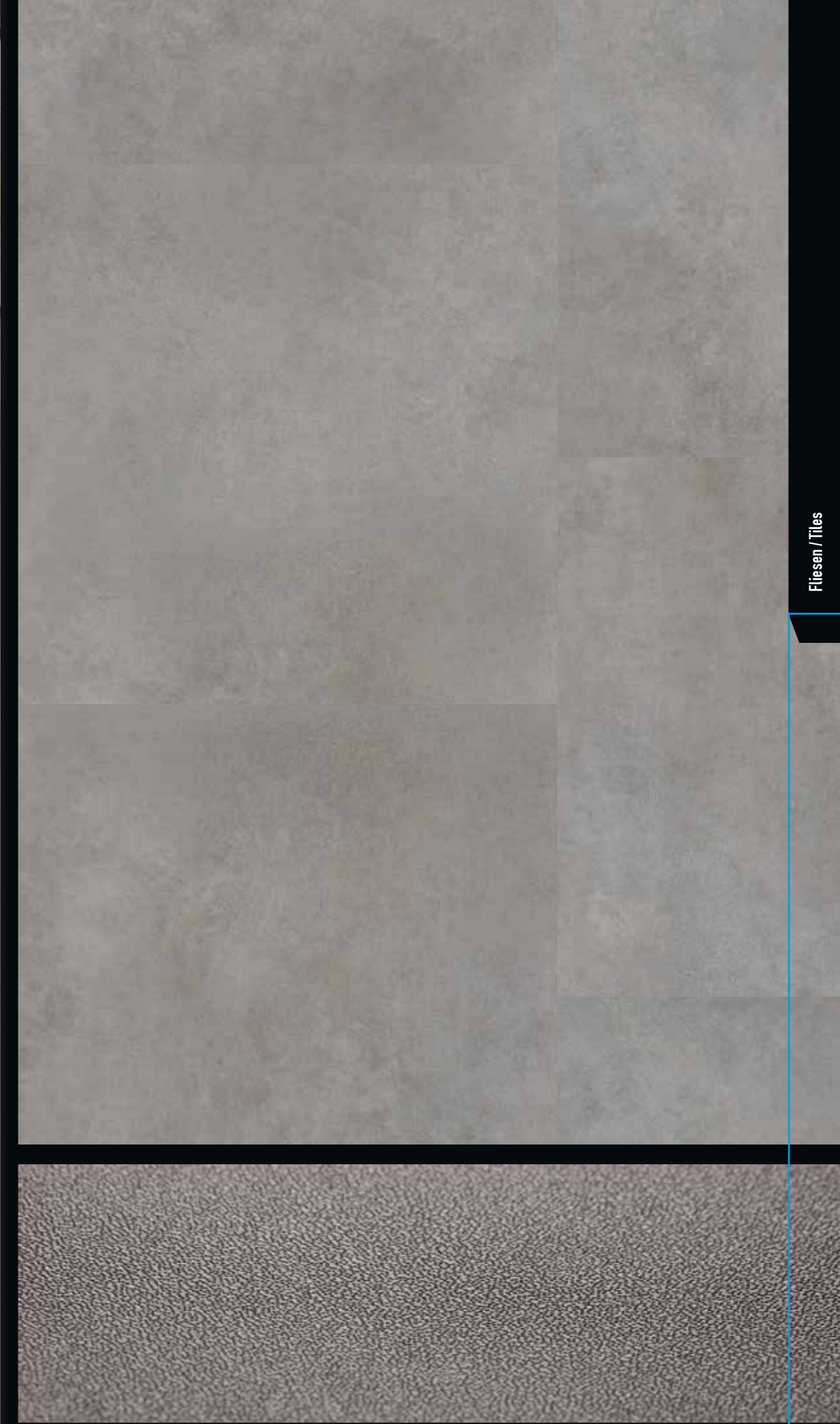

TR 990 -/55



600 x 600 x 2,5 mm



Mehr zum Dekor!
More about the design!



TR 991 -/55



600 x 600 x 2,5 mm



Mehr zum Dekor!
More about the design!

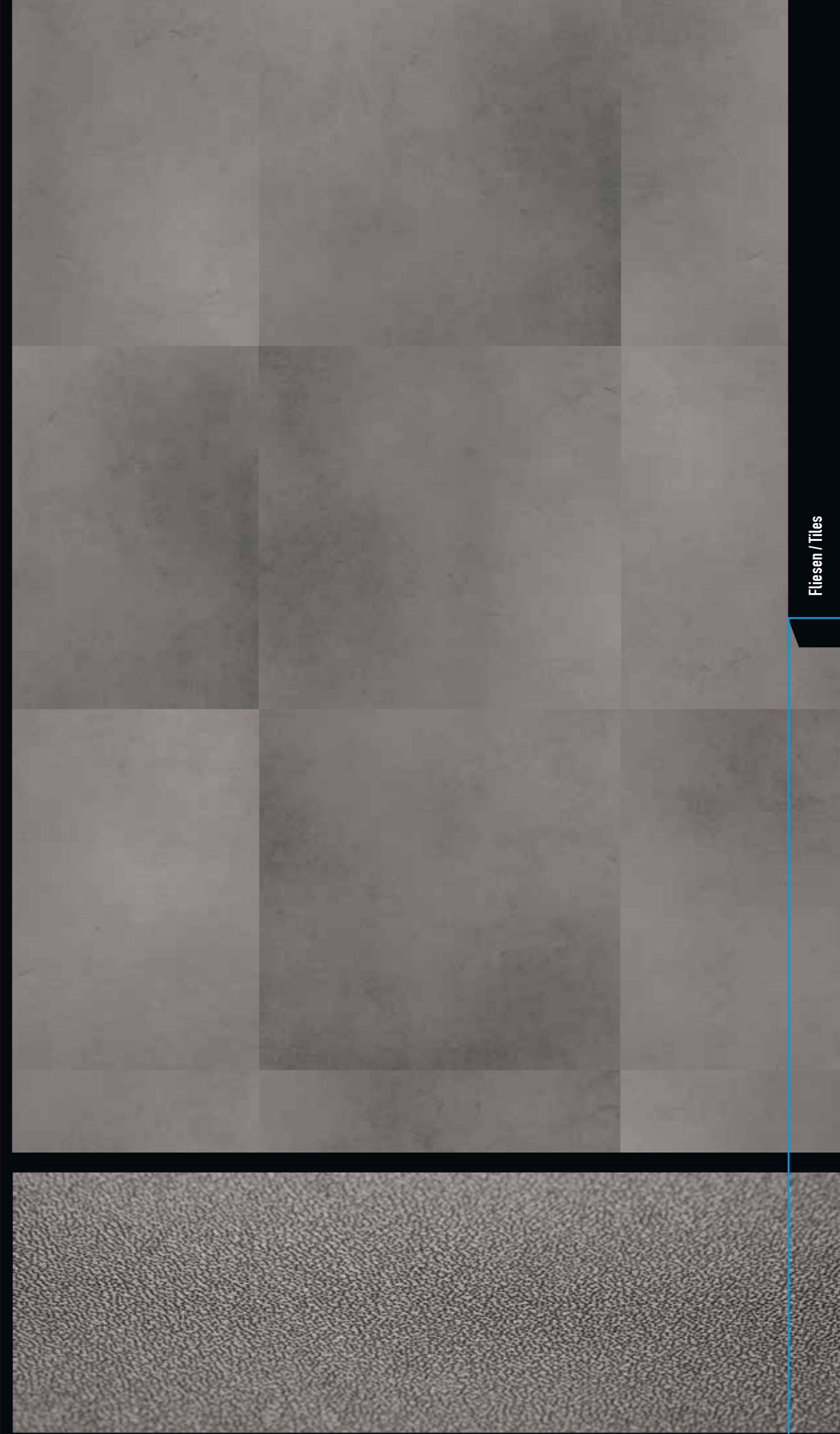

TR 420 -/55

457 x 457 x 2,5 mm



Mehr zum Dekor!
More about the design!

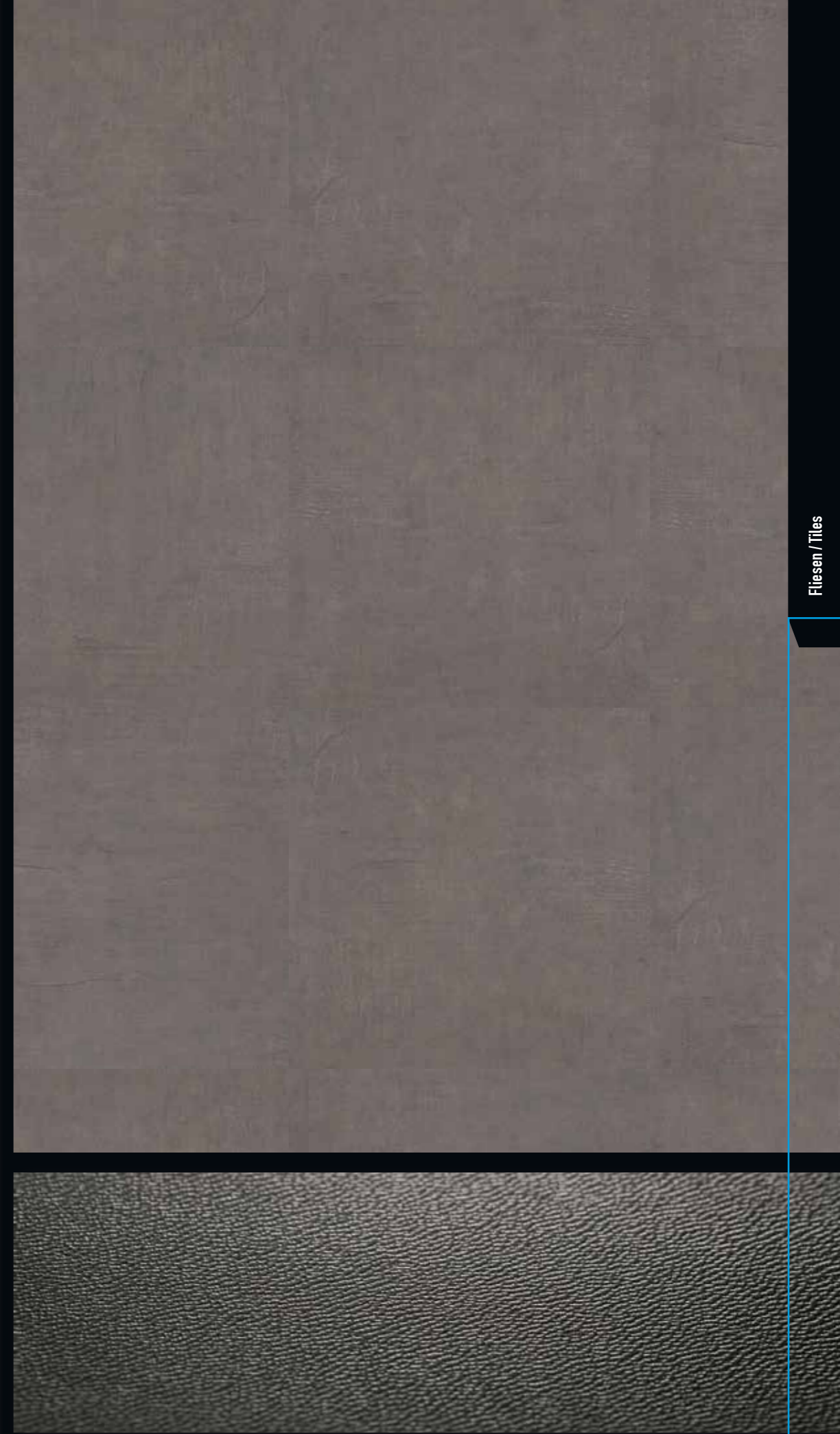

Fliesen / Tiles

TR 556 -/55



457 x 457 x 2,5 mm



Mehr zum Dekor!
More about the design!



Mit optionalen schwarzen Fugenprofilen
With optional feature strips black

ST 920 -/55



600 x 600 x 2,5 mm



Mehr zum Dekor!
More about the design!

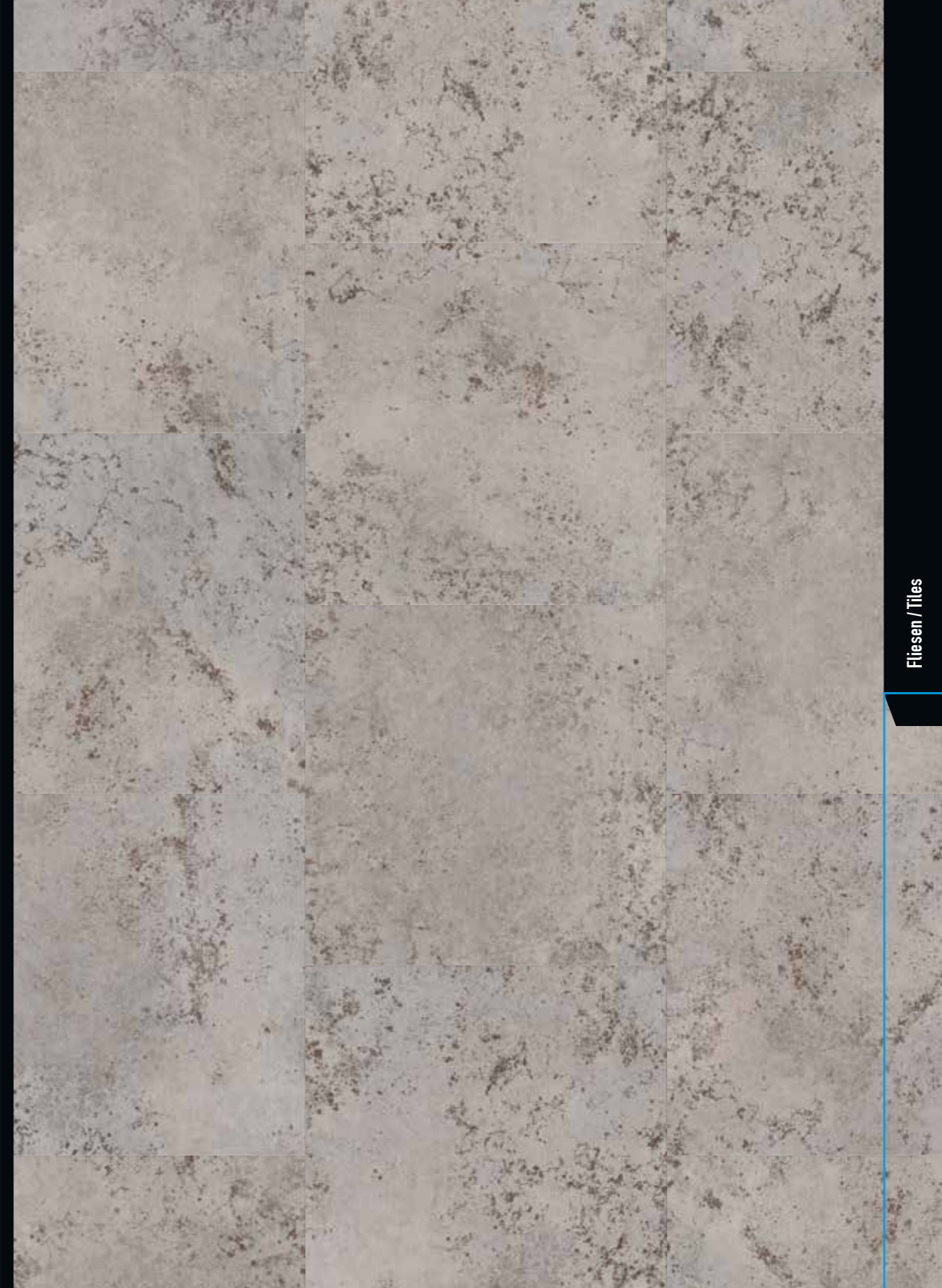

ST 480 -/55



457 x 457 x 2,5 mm



Mehr zum Dekor!
More about the design!



Mit optionalen silbergrauen Fugenprofilen
With optional feature strips silver grey

ST 450 -/55



457 x 457 x 2,5 mm



Mehr zum Dekor!
More about the design!



Mit optionalen schwarzen Fugenprofilen
With optional feature strips black

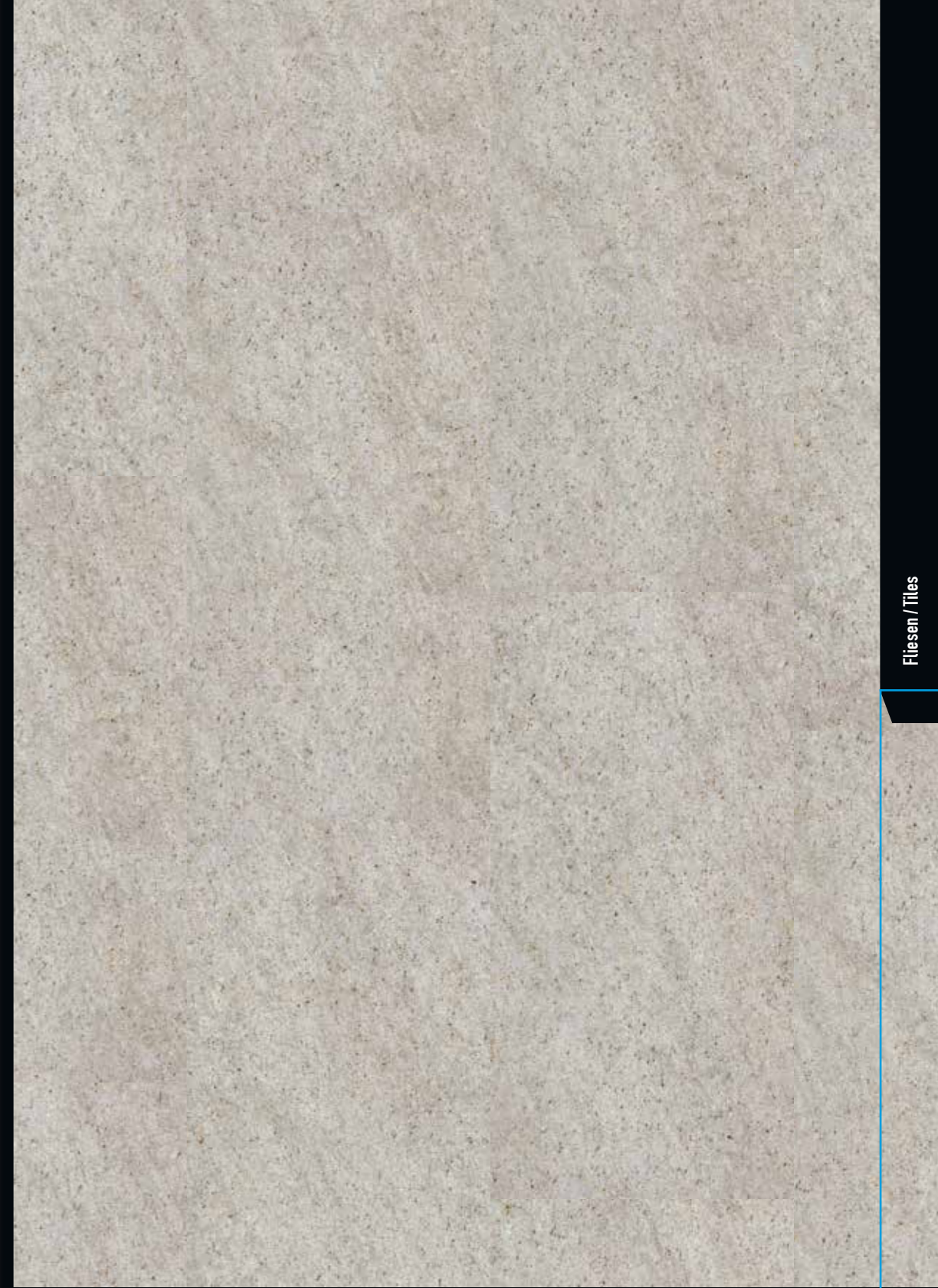

ST 760 -/55



610 x 305 x 2,5 mm



Mehr zum Dekor!
More about the design!



Mit optionalen silbergrauen Fugenprofilen
With optional feature strips silver grey

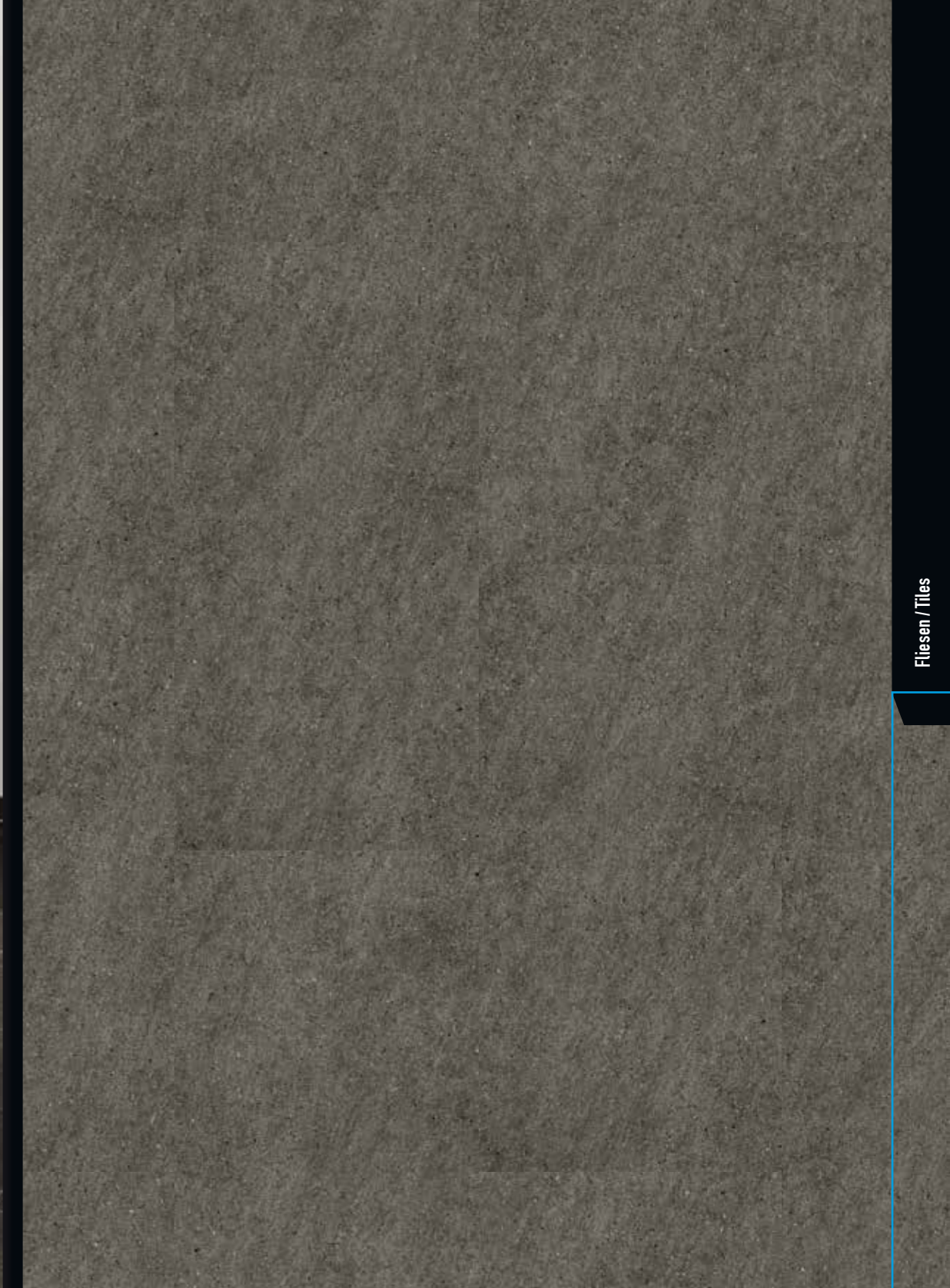

ST 761 -/55



610 x 305 x 2,5 mm



Mehr zum Dekor!
More about the design!



Mit optionalen silbergrauen Fugenprofilen
With optional feature strips silver grey

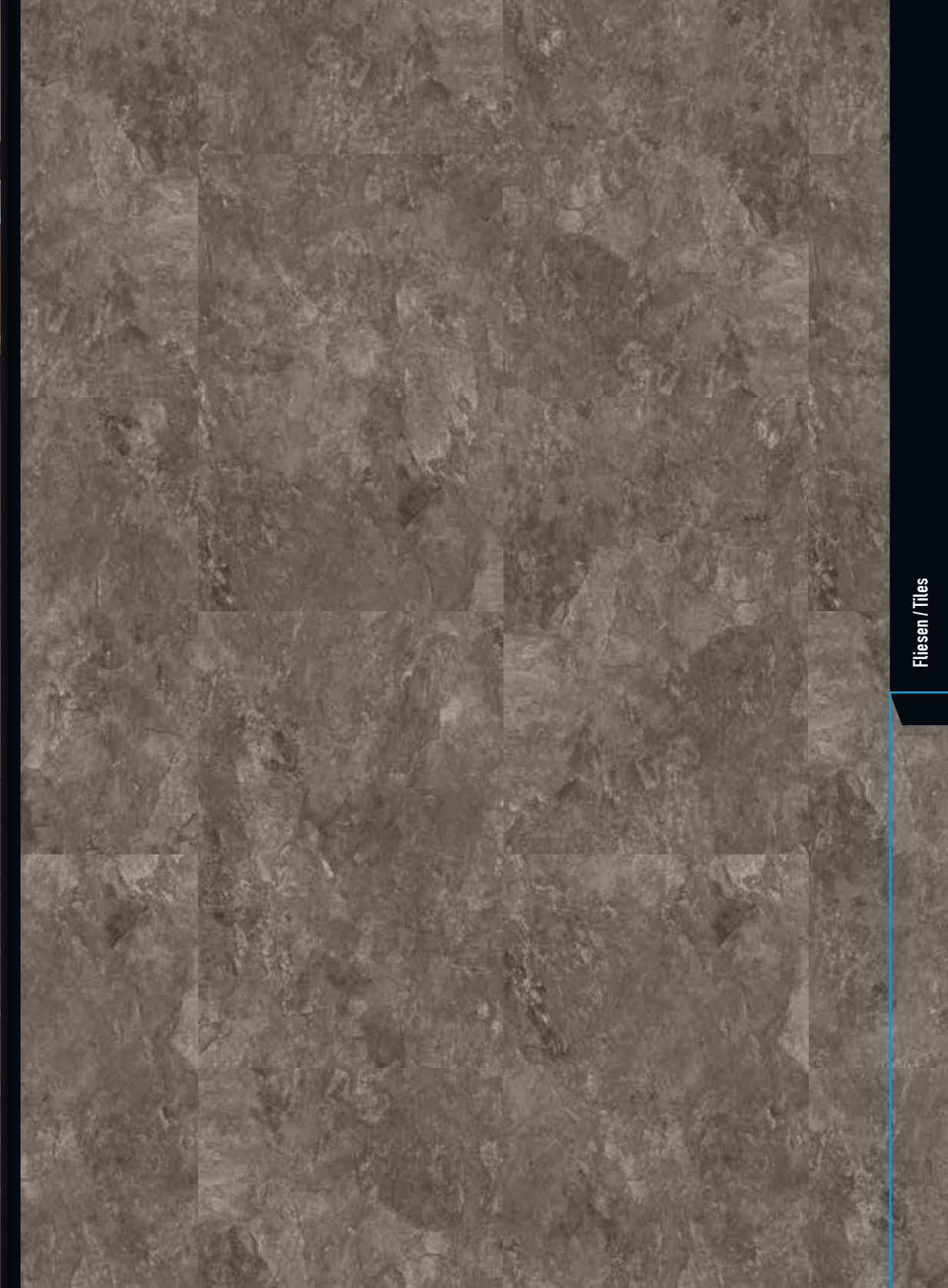

SL 307 -/55



457 x 305 x 2,5 mm



Mehr zum Dekor!
More about the design!



Mit optionalen silbergrauen Fugenprofilen
With optional feature strips silver grey

SL 306 -/55



457 x 305 x 2,5 mm



Mehr zum Dekor!
More about the design!

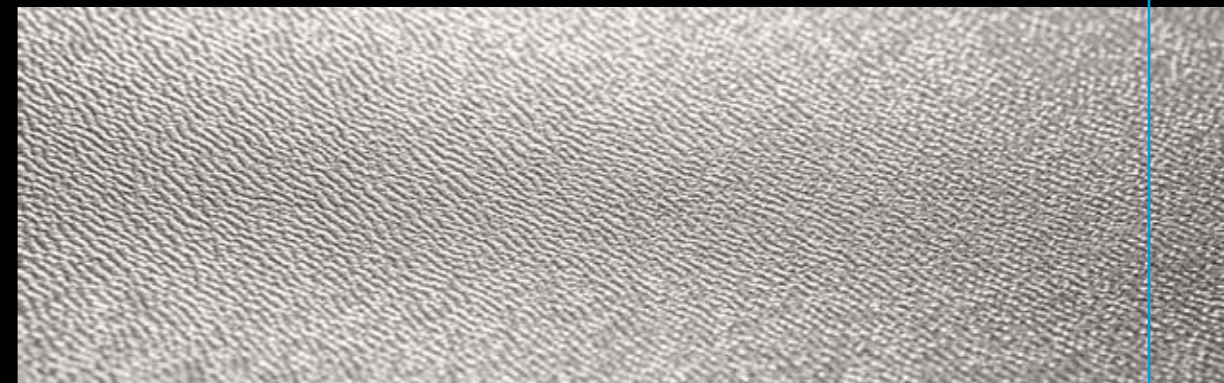
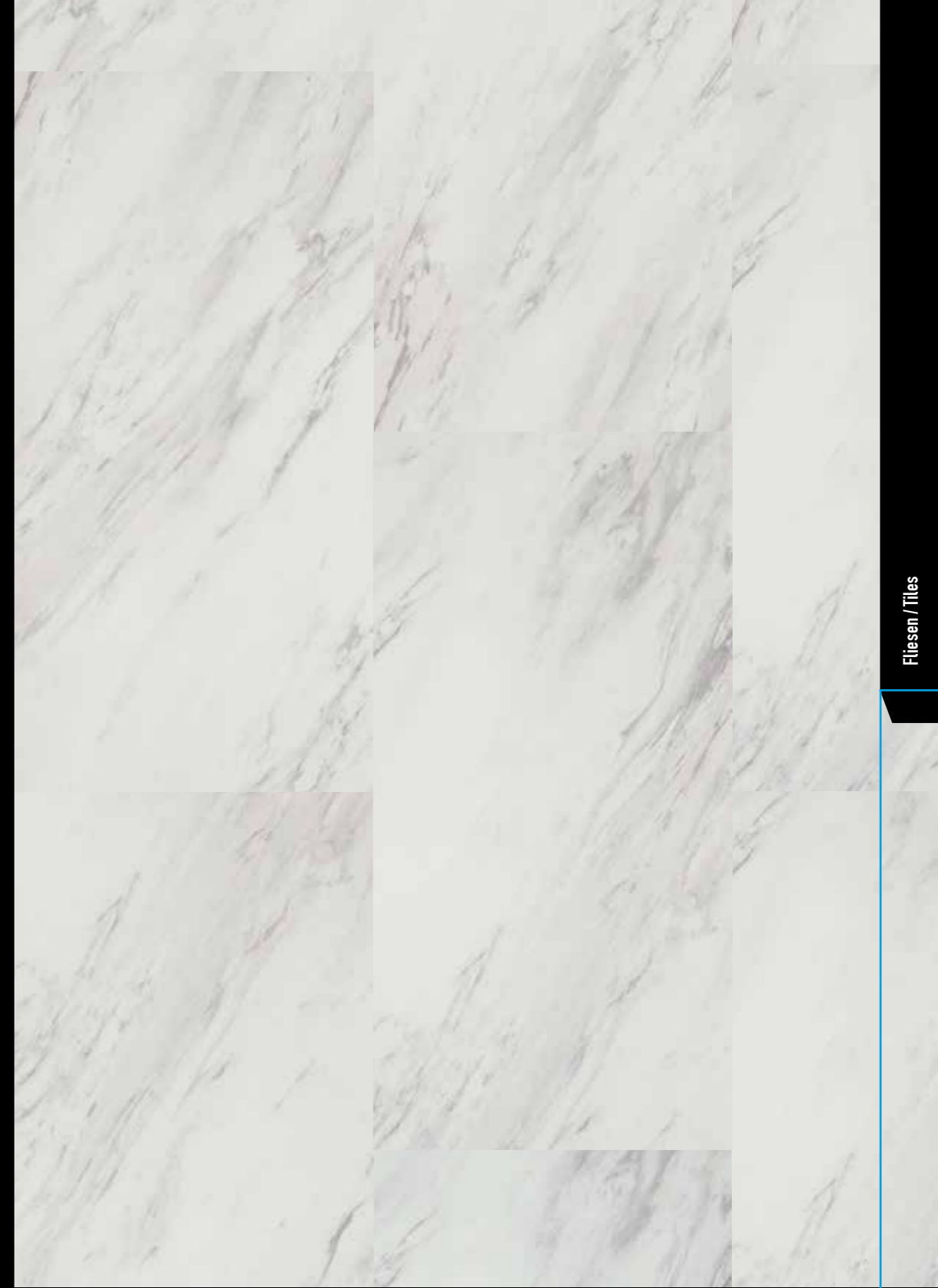

Fliesen / Tiles

MA 300 -/55



914 x 457 x 2,5 mm



Mehr zum Dekor!
More about the design!

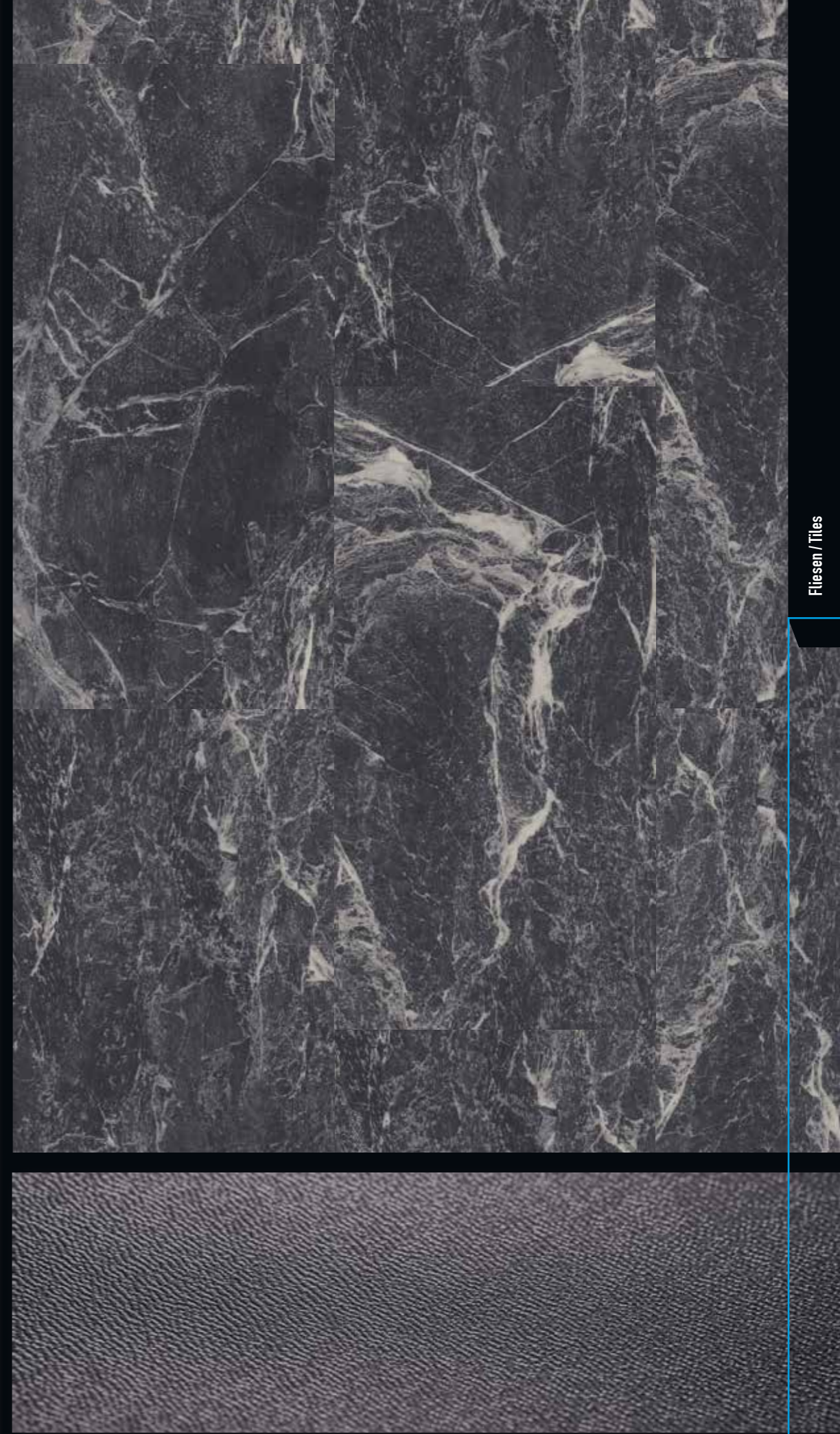

Fliesen / Tiles

MA 310 -/55



914 x 457 x 2,5 mm



Mehr zum Dekor!
More about the design!

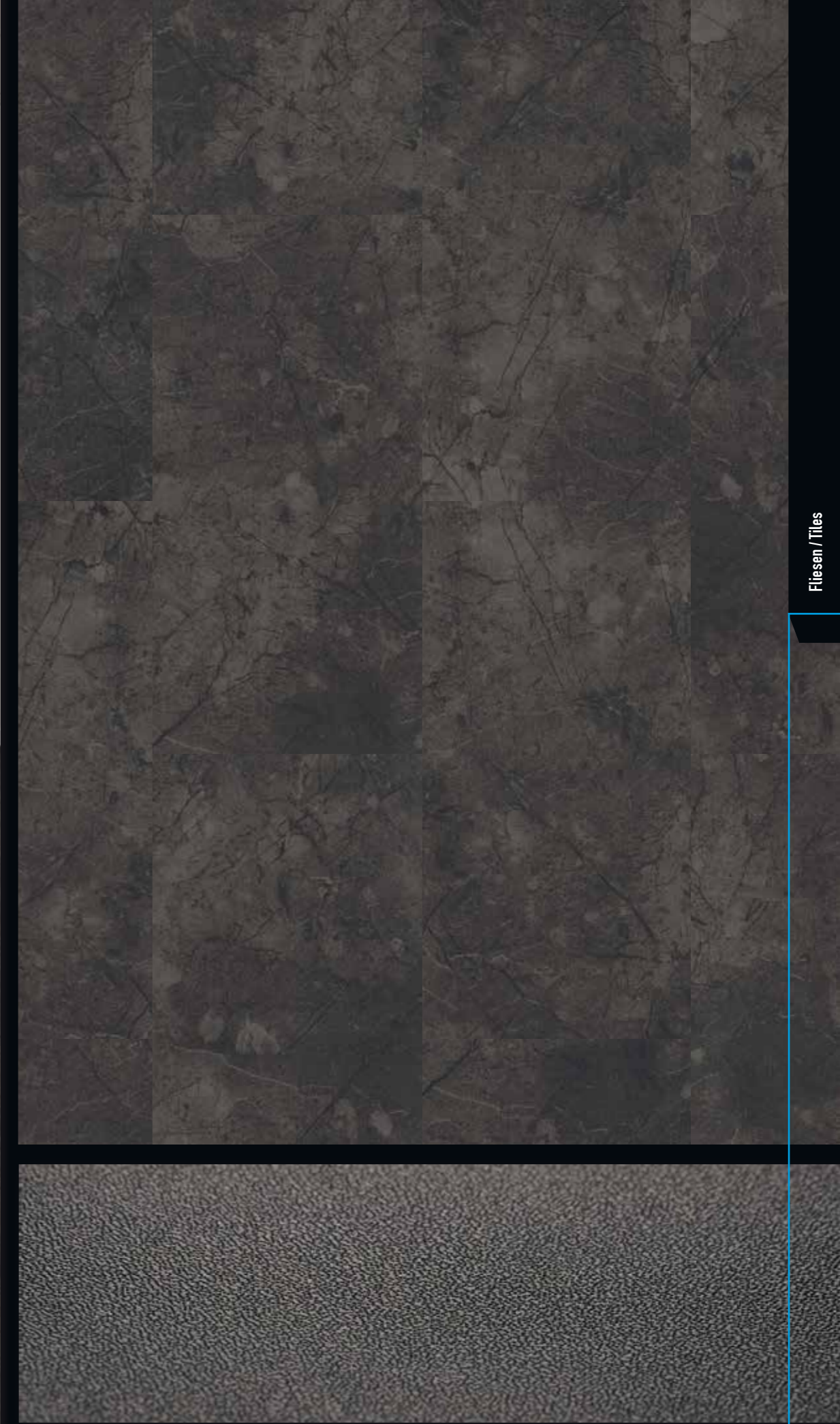

Fliesen / Tiles

ST 400 -/55



610 x 305 x 2,5 mm



Mehr zum Dekor!
More about the design!



Mit optionalen Schlüsselsteinen ST 941
With optional key stones ST 941

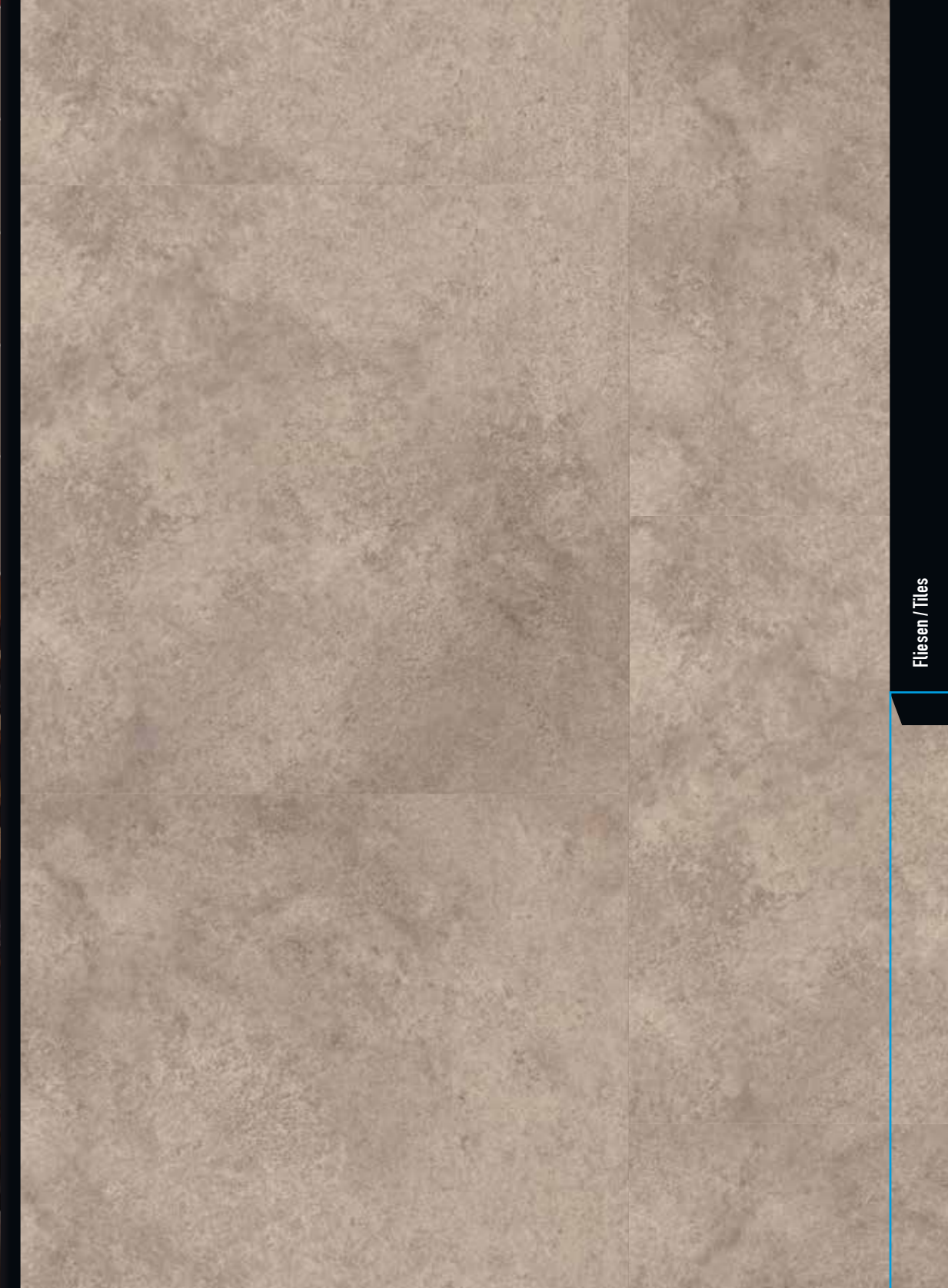

ST 940 -/55



600 x 600 x 2,5 mm



Mehr zum Dekor!
More about the design!

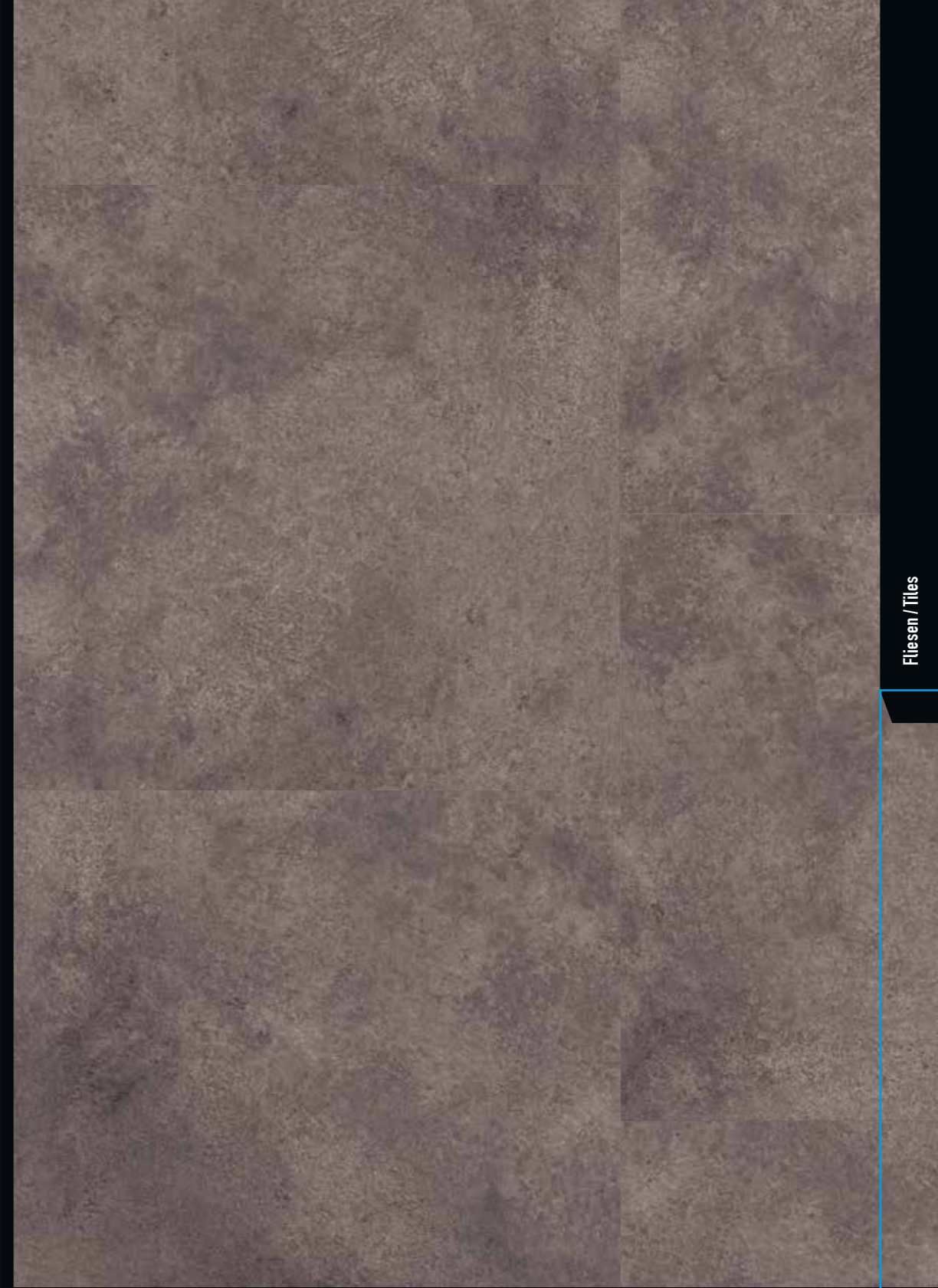

Fliesen / Tiles

ST 941 -/55



600 x 600 x 2,5 mm



Mehr zum Dekor!
More about the design!

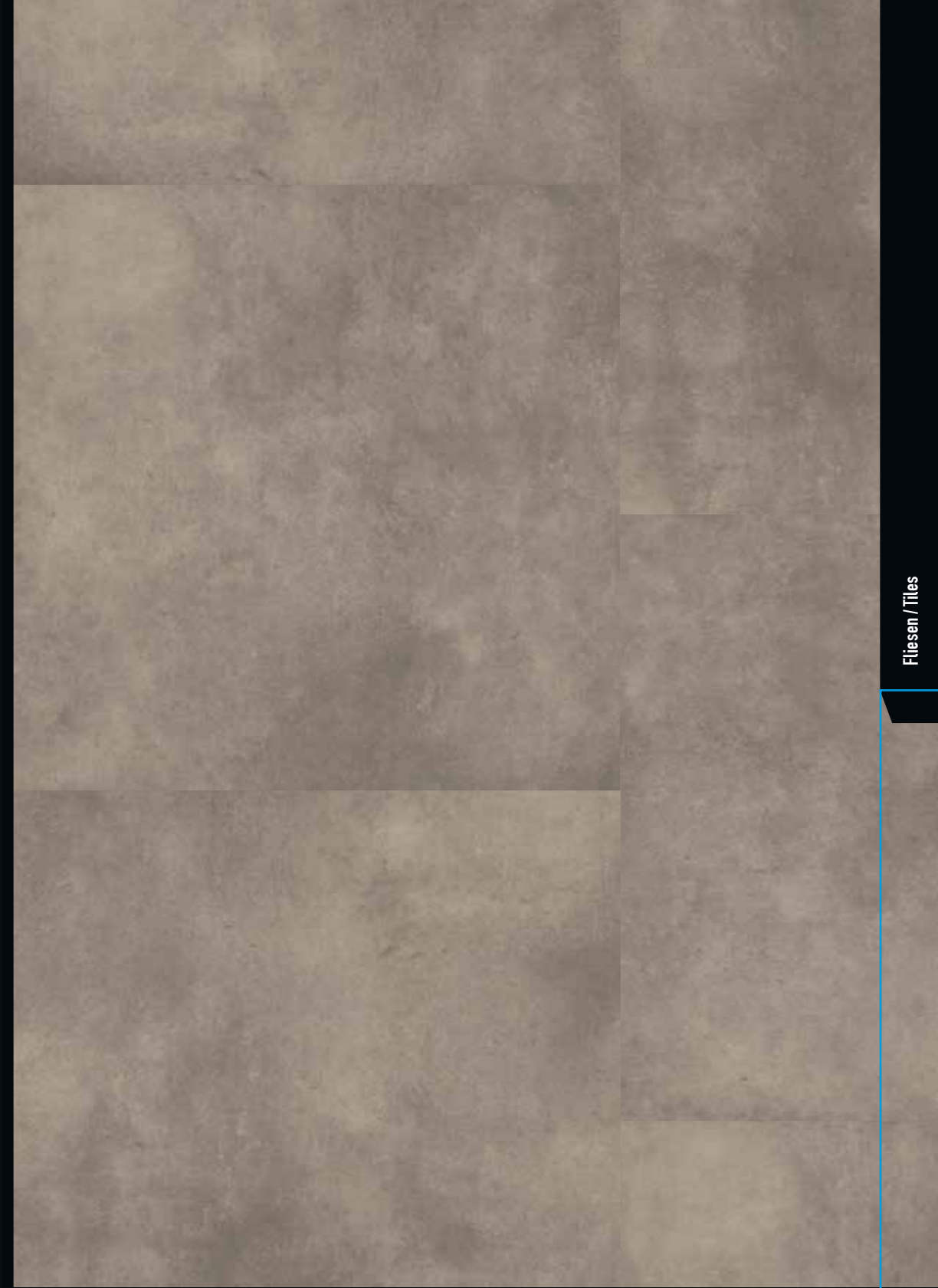

ST 950 -/55



600 x 600 x 2,5 mm



Mehr zum Dekor!
More about the design!

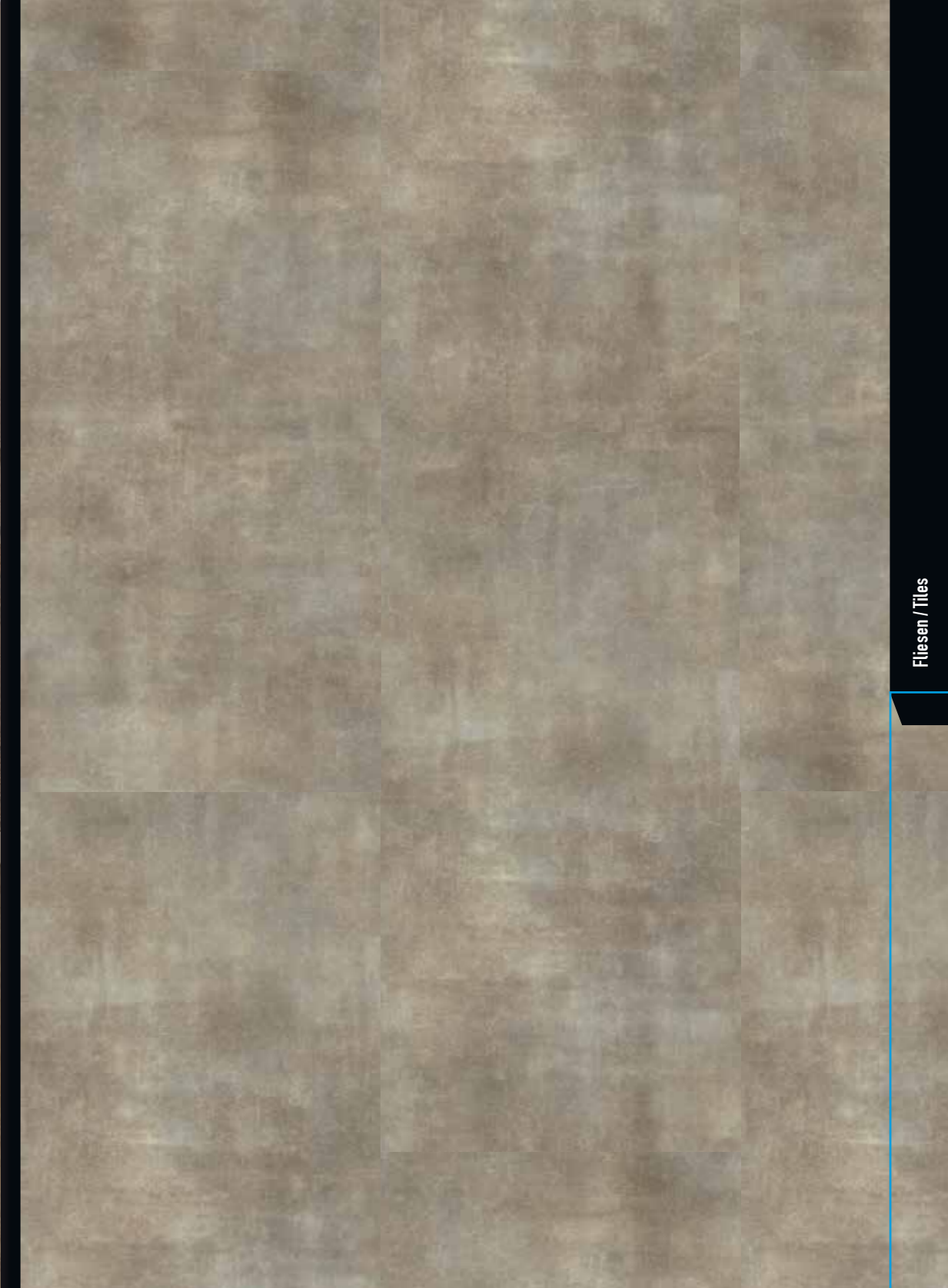

ST 225 -/55



914 x 457 x 2,5 mm



Mehr zum Dekor!
More about the design!

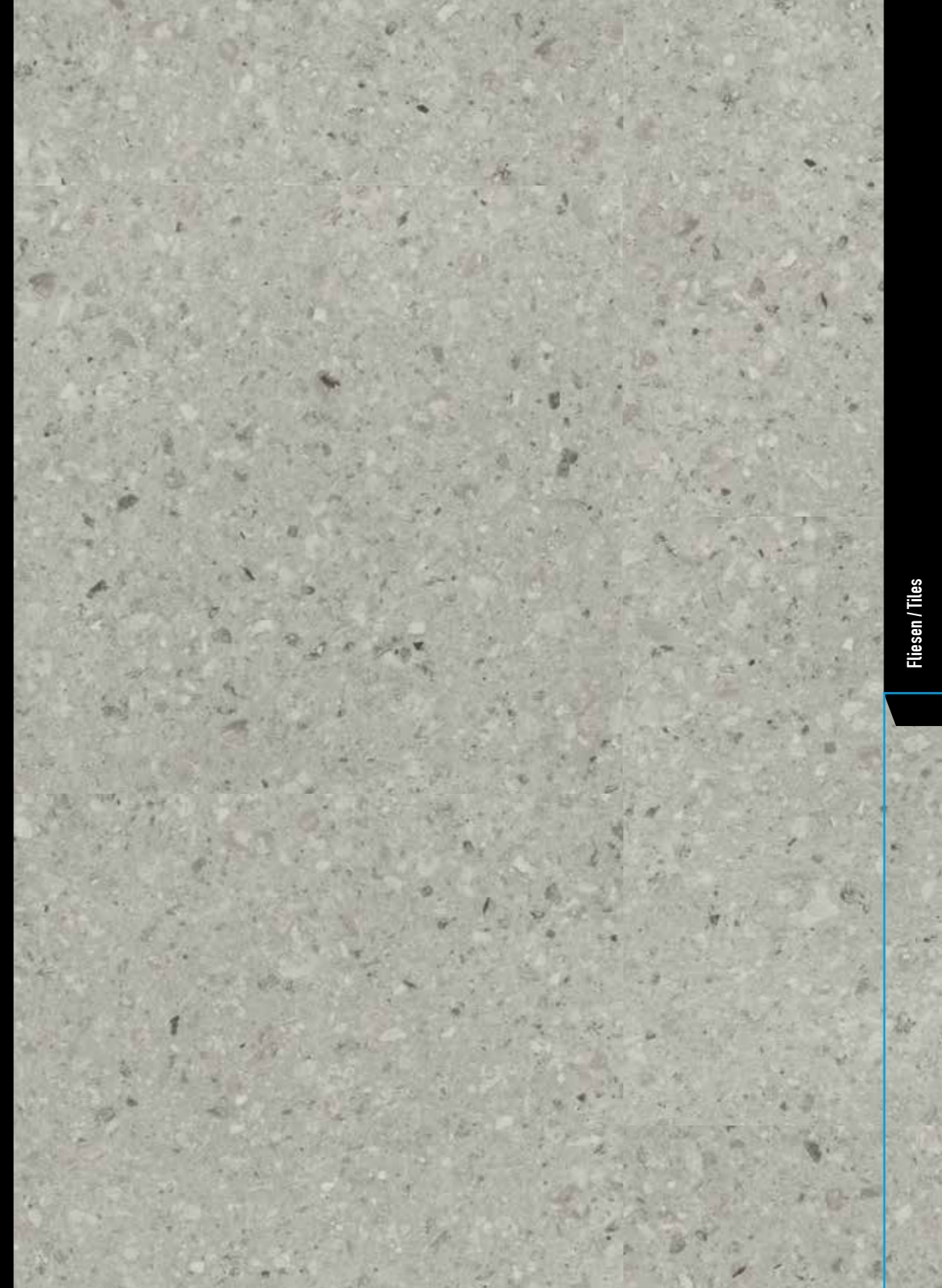

ST 945 -/55



600 x 600 x 2,5 mm



Mehr zum Dekor!
More about the design!

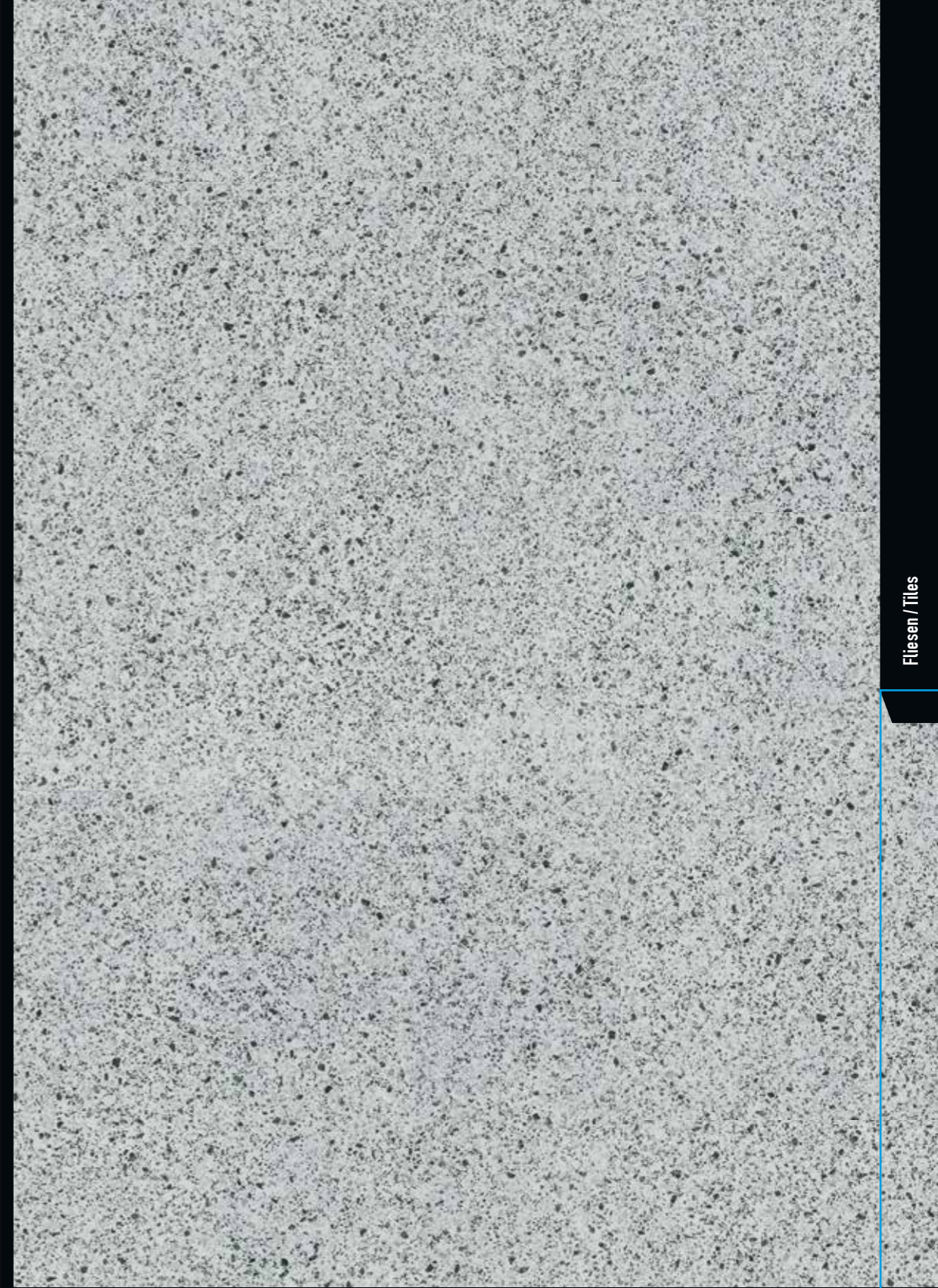
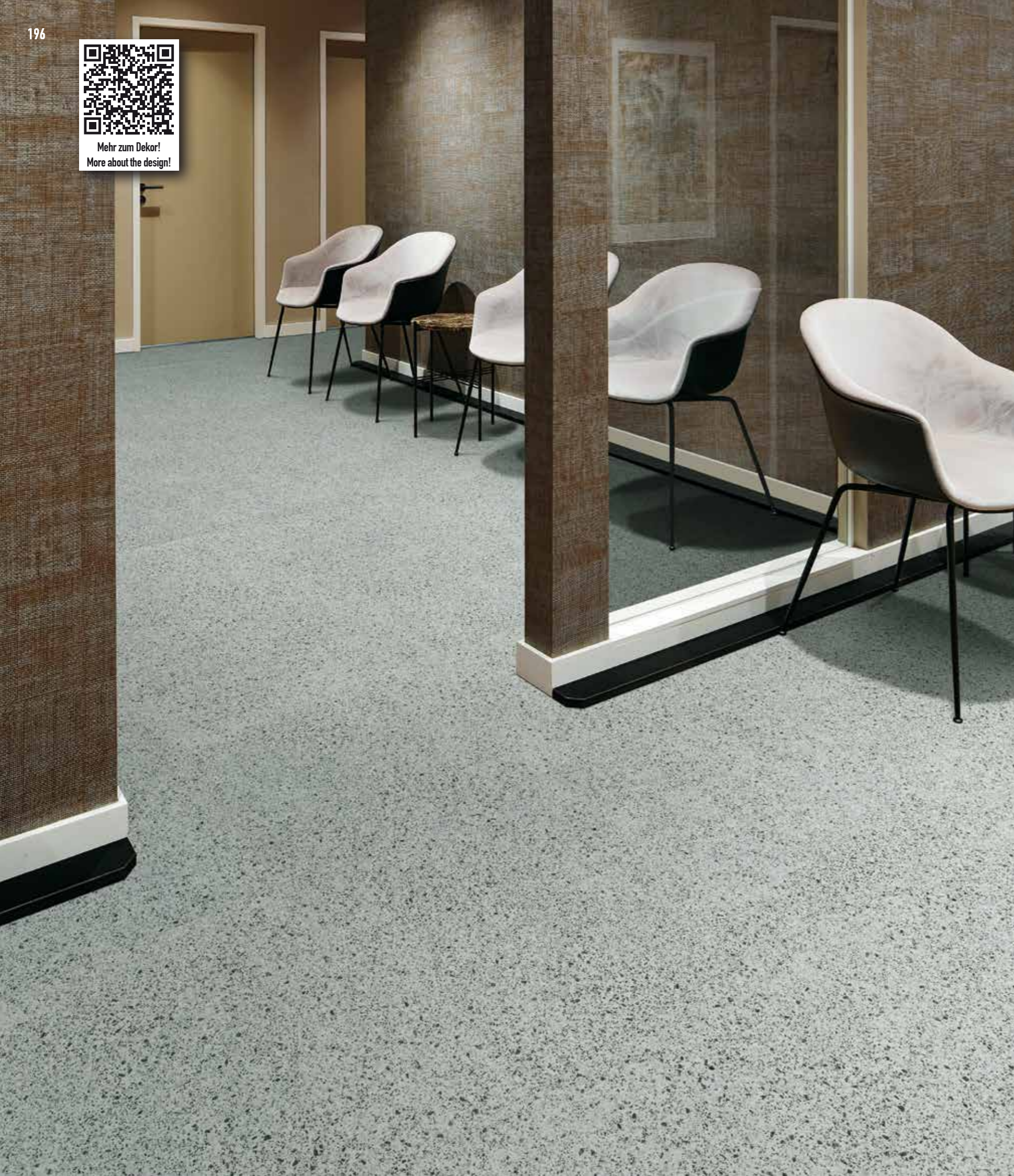

ST 955 -/55



600 x 600 x 2,5 mm



Mehr zum Dekor!
More about the design!

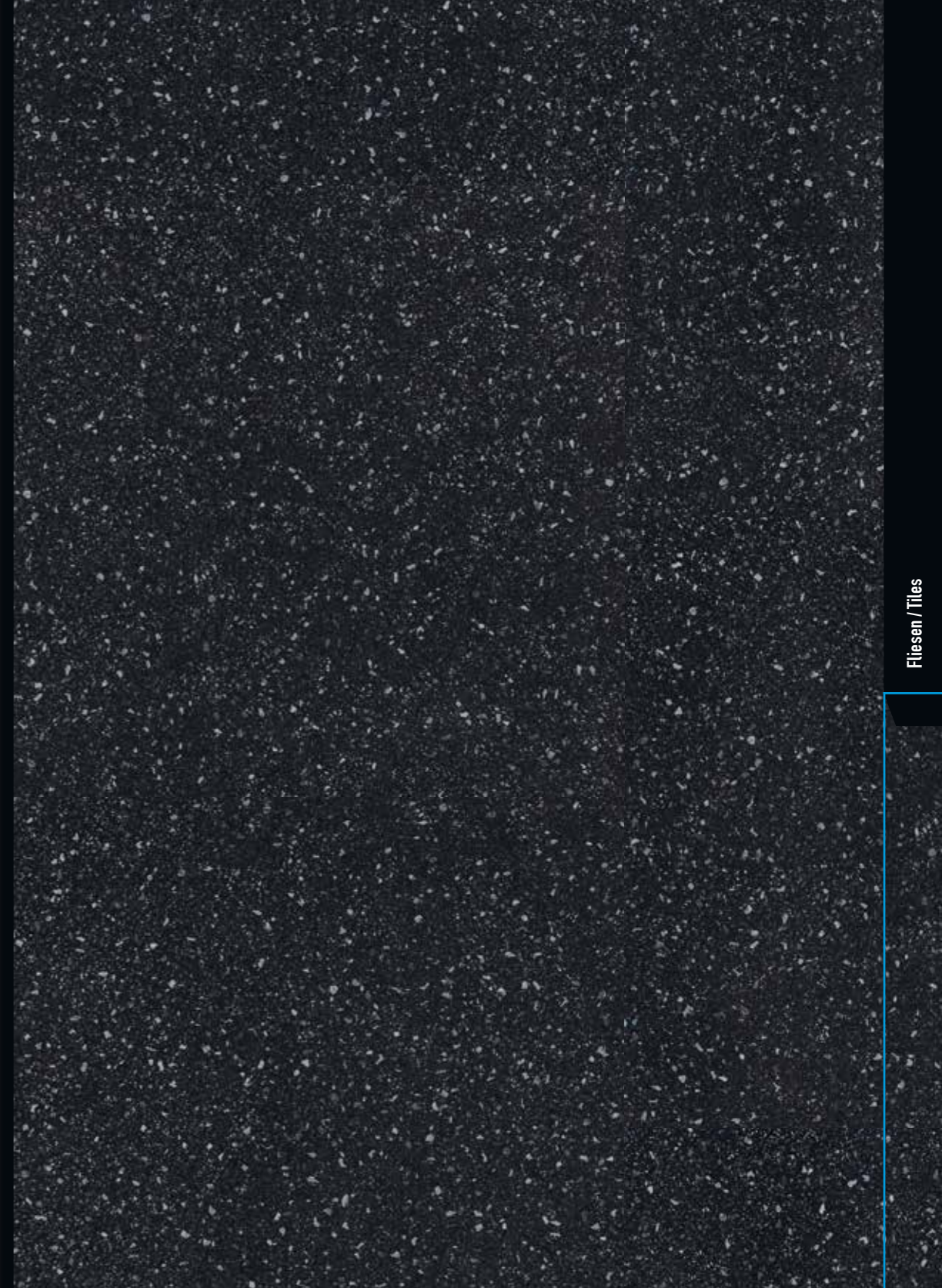

ST 956 -/55



600 x 600 x 2,5 mm



Mehr zum Dekor!
More about the design!

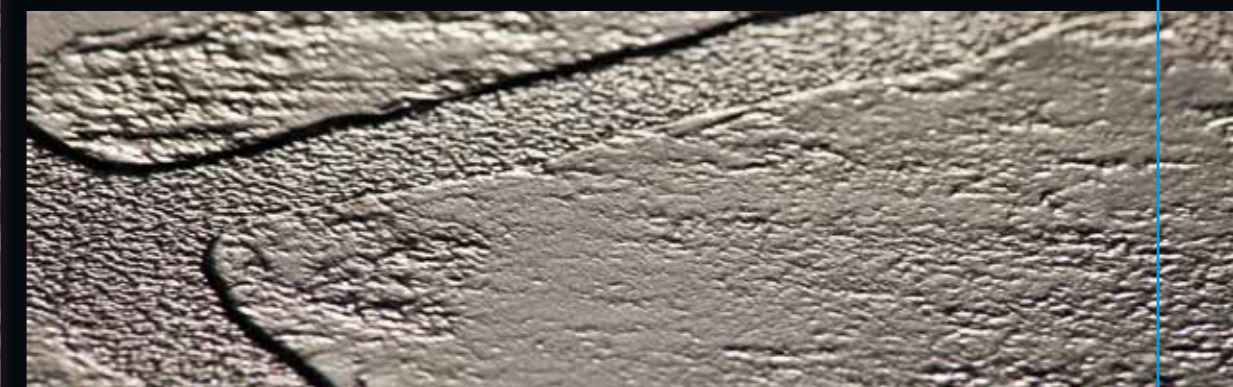

Fliesen / Tiles

ST 750 -/55

SYNC

457 x 457 x 2,5 mm

Übersicht Fliesen

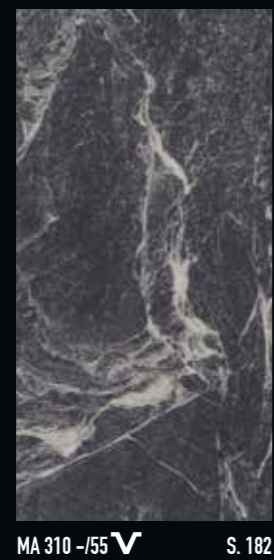
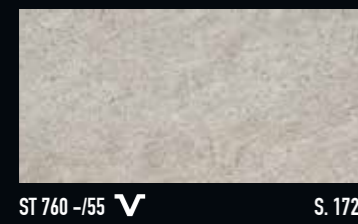
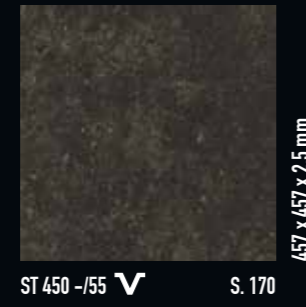

Overview tiles

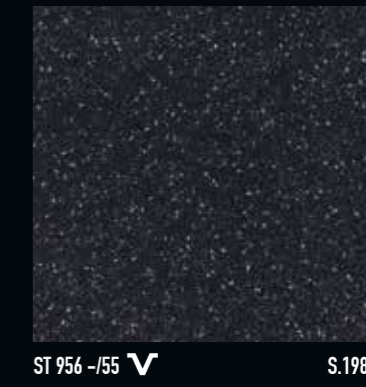
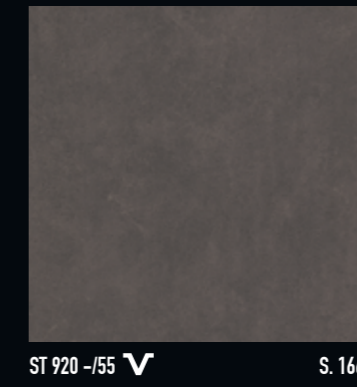
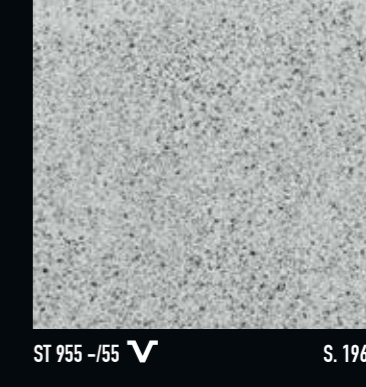
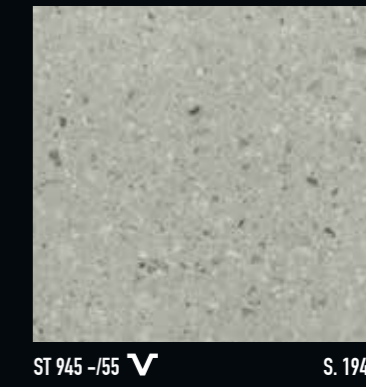

Wissenswertes Good to know

Die Vorteile von Designbodenbelägen

PROJECT FLOORS hat sich auf Designbodenbeläge spezialisiert, da sie in vielen Anwendungsgebieten ihre Vorzüge ausspielen können. Die Kombination der Optik von Echtholz oder –stein mit der Strapazierfähigkeit und Reinigungs-leichtigkeit eines Kunststoffbelages spricht Eigentümer, Betreiber, Planer und Architekten gleichermaßen an und ermöglicht die optimale Verbindung von Design und Nutzen.

Für eine kostenbewusste Realisierung Ihrer Raumgestaltung bieten wir Ihnen fünf entsprechende Nutzschichten mit unterschiedlichen Beanspruchungsklassen an, perfekt abgestimmt auf die jeweiligen Anforderungen und Gegebenheiten Ihres Hauses. Beachten Sie neben der Ihnen vorliegenden floors@work Kollektion also bitte auch die Dekore der floors@home Kollektion.

Nah am Original

Bodenbeläge von PROJECT FLOORS sind kaum vom natürlichen Vorbild zu unterscheiden. Ein authentisches Abbild der Holz- oder Steinvorlage und eine auf das Dekor sorgfältig angepasste Oberflächenprägung wirken auch auf den zweiten und dritten Blick täuschend echt. Der optische Eindruck wird durch das realistische Begehgeräusch abgerundet, das ebenso nah am Original ist.

Ein Boden – unzählige Möglichkeiten

Bodenbeläge von PROJECT FLOORS geben Ihnen unendliche Möglichkeiten für die individuelle Raumgestaltung. Unterschiedlichste Verlegemuster, Kombinationen von verschiedenen Dekoren oder der Einsatz von Fugenprofilen oder Design-Fugenprofilen – Ihren Ideen sind keine Grenzen gesetzt.

Ideal für Neubau, Umbau oder Sanierung

Mit einer Materialstärke von nur 2,5 mm sind die Beläge der floors@work Kollektion die perfekte Lösung für alle Bau- und Renovierungsmaßnahmen. Das geringe Flächengewicht von 3,81 kg/m² bringt auch für die Statik keine Probleme.

Behaglichkeit in allen Räumen

Unsere Böden machen vor keinem Raum halt. Durch die Unempfindlichkeit gegen Feuchtigkeit quellen die Beläge weder auf noch brechen sie. Somit ist die Verlegung beispielsweise auch in Hotelbadezimmern problemlos möglich. Und natürlich sind PROJECT FLOORS Bodenbeläge auch geeignet für den Einsatz von Fußbodenheizungen.

Pflegeleicht, hygienisch und unbedenklich

PROJECT FLOORS Bodenbeläge sind kostengünstig und einfach zu reinigen. Ein Vorteil, der gerade in Arztpraxen und Pflege- und Rehaeinrichtungen geschätzt wird. In unserer Produktion werden keine Recycling-Kunststoffe mit unbekannter Herkunft verwendet, sondern nur Granulate mit einwandfrei nachvollziehbarer Zusammensetzung. So stellen wir sicher, Ihnen ausschließlich gesundheitlich unbedenkliche Produkte zu liefern, was uns in regelmäßigen Tests auch immer wieder bestätigt wird.

The advantages of design floor coverings

PROJECT FLOORS is specialised in design floor coverings which offer superior features in many applications. The combination of real wood or real stone looks with the durability and the easy cleaning of a vinyl covering appeals to owners, users, planners and architects alike and allows the marriage of design and function.

To deliver economic solutions for your projects we offer five wearlayers with different performance specifications, perfectly matched to the specific demands of your establishment. So please also take a look at the designs in the floors@home collection along with the floors@work collection at hand.

Close to the original

It is often difficult to differentiate flooring from PROJECT FLOORS and the actual natural material. Our authentic representations of original wood and stone designs along with carefully selected surface textures deliver a truly realistic appearance – not just at first glance but with much closer scrutiny. This visual impression is further enhanced by the natural underfoot sound; again very close to the original.

One floor – countless options

Flooring from PROJECT FLOORS offers you endless possibilities for individual interior designs. With various installation options, combinations of the different designs and the use of feature and design strips, there are no limits to your design ideas.

Perfect for new buildings, refurbishment or renovation

The total thickness of only 2.5 mm makes the floors@work collection the perfect solution for all building and renovation projects. The low weight of 3.81 kg/m² is ideal for virtually all situations.

Cosiness in all rooms

Our floors aren't just limited to certain rooms. Being resistant to moisture and humidity they won't swell, crack or break. Hence, for example an installation in hotel bathrooms is no problem whatsoever. And of course, PROJECT FLOORS flooring can be installed over under-floor heating.

Easy to clean, hygienic and harmless

Flooring from PROJECT FLOORS is easy and cost effective to clean. A benefit appreciated especially in medical practices, nursing homes and rehab. facilities. All raw materials used in our products, including all recycled content have full traceability. This means that we can ensure that only harmless raw materials are used, as you would expect this is checked and confirmed by regular testing.



Mehr zum Design!
More about the design!

Designbodenbeläge ohne Phthalatweichmacher

Design floor coverings with non-phthalate plasticizer

Hexamoll® DINCH

PROJECT FLOORS verzichtet vollständig auf die Verwendung von phthalat-haltigen Weichmachern in der Produktion all seiner Bodenbeläge.

Stattdessen kommt ausschließlich die sichere Alternative Hexamoll® DINCH zum Einsatz, die von BASF für Anwendungen in engem menschlichen Kontakt entwickelt wurde. Hierzu gehören insbesondere die sensiblen Bereiche Spielzeug, Medizinprodukte oder Lebensmittelverpackungen.

Hexamoll® DINCH ist der am besten untersuchte Nicht-Phthalatweichmacher. Unabhängige Gutachten belegen:

- hervorragende toxikologische Eigenschaften
- die Zulassung für Babyartikel
- mehr als 6fach bessere Grenzwerte für die Migration in Lebensmittel
- beste Werte in der Ökoeffizienz-Analyse im Sinne einer ganzheitlichen Betrachtung ökologischer und ökonomischer Aspekte über den Lebenszyklus eines Produktes

PROJECT FLOORS has completely stopped using plasticizers containing phthalates in the production of all its floor coverings.

Instead, only the safe alternative Hexamoll® DINCH will be used, developed by BASF for uses in close human contact. These especially include the sensitive areas of toys, medical articles or food packaging.

Hexamoll® DINCH is the best-researched non-phthalate plasticizer. Independent assessments show:

- Excellent toxicological properties
- Approval for baby articles
- More than six-fold better limits for migration in food
- The best ranking in ecological efficiency analyses, considered holistically in terms of ecological and economical aspects throughout the life cycle of a product



Wo kommt Hexamoll® DINCH auch zum Einsatz?

Where else is Hexamoll® DINCH put to use?

Spielzeug und Kinderartikel:

- Puppen und Figuren
- Aufblasbare Spielzeuge und Bälle
- Schwimmhilfen
- Baby- und Kinderartikel

Lebensmittelverpackungen:

- Frischhaltefolie
- Frischesiegel
- Kronkorken
- Dichtringe

Sport- und Freizeitartikel:

- Gymnastikbälle
- Turnmatten
- Massagebälle
- Duschvorhänge

Medizinische Artikel:

- Blutbeutel
- Beatmungsschläuche
- Katheter
- Einweghandschuhe

Toys and children's articles:

- Dolls and figurines
- Inflatable toys and balls
- Swimming aids
- Baby and children's articles

Food packaging:

- Cling films
- Freshness seals
- Cap closures
- Sealing rings

Sport and leisure articles:

- Gymnastic balls
- Exercise mats
- Massage balls
- Shower curtains

Medical articles:

- Blood bags
- Respiratory tubes
- Catheters
- Disposable gloves

Umweltschutz und Nachhaltigkeit

Environment and sustainability

PROJECT FLOORS legt großen Wert auf die Umweltverträglichkeit aller Prozesse und Produkte.

Mit der Zertifizierung unserer Produktionsstandorte nach der weltweit gültigen und bedeutendsten Umweltmanagementnorm ISO 14001:2015 haben wir uns selbst verpflichtet, bei allen unternehmerischen Entscheidungen die Umweltaspekte zu berücksichtigen und die Umweltsituation kontinuierlich zu verbessern. Dies bedingt zum Beispiel einen sorgsam Einsatz aller Ressourcen im Sinne einer nachhaltigen Wertorientierung, den Schutz von Wasser- und Luftqualität oder die Reduktion von Abfall während der gesamten Fertigung. Gewährleistet wird die Einhaltung der Vorgaben durch regelmäßige Überprüfungen einer unabhängigen Zertifizierungsstelle.

Die Herstellung unserer Bodenbeläge erfolgt deutlich energieeffizienter als bei vielen Alternativprodukten. Die lange Lebensdauer bei geringem Unterhaltsaufwand in der täglichen Reinigung trägt ebenfalls zur guten Gesamtbilanz der eingesetzten Energie während der Produktion bei.

Selbst nach dem Ende der Nutzung ergibt sich durch viele Recyclingmöglichkeiten ein positives ökologisches Gesamtbild. So kann das Altmaterial durch seine einheitliche Zusammensetzung nach einer Aufarbeitung wieder an Stelle von neuen Rohstoffen in den Produktionsprozess integriert werden. Eine umweltgerechte Entsorgung und Wiederverwendung unserer Produkte und Verpackungen unterstützen wir durch die Mitgliedschaft in den relevanten Organisationen.

PROJECT FLOORS attaches great importance to the environmental safety of all its processes and products.

With the certification of our production facilities to the worldwide and most significant environmental management system ISO 14001:2015 we have pledged ourselves to considering environmental issues and continuously improve the environmental situation with every corporate decision. This involves for example a diligent use of all resources in terms of sustainability, protection of water and air quality and reduction of waste during the entire production facility. Compliance with every requirement is guaranteed by regular audits by independent certification authorities.

The manufacture of our floor coverings consumes much less energy than many alternative products. Long life cycles and the low maintenance requirement for daily cleaning also contributes to the positive balance of energy used during production.

Even at the end of useful life the various possibilities for recycling reinforce the positive ecological picture. Due to the flooring's composition processed waste can be reused saving new raw materials. PROJECT FLOORS supports the professional recycling of our products and packaging with memberships of the relevant institutions.



Raumklima

Indoor air climate

PROJECT FLOORS Bodenbeläge werden regelmäßig und wiederholt auf Emissionen geprüft, um das Raumklima in öffentlichen und privaten Gebäuden nicht zu beeinflussen.

Daher haben alle unsere Bodenbeläge das „Indoor Air Comfort Gold“-Zertifikat. Als Grundlage für diese Prüfung werden alle relevanten Anforderungen in der EU zur Innenraumluft herangezogen, um den jeweils strengsten Grenzwert als Messlatte festzulegen. Dabei belegt das normale Niveau „Indoor Air Comfort“ die Einhaltung aller Anforderungen von Behörden an die Emissionswerte, das höhere Gold-Niveau weist zusätzlich noch die Unterschreitung der Grenzwerte aller freiwilligen Gütezeichen aus.

PROJECT FLOORS floor coverings are regularly and repeatedly tested for low emissions to avoid a influence on the indoor climate in commercial and residential buildings.

Therefore all our floor coverings are in accordance to the "Indoor Air Comfort" certificate. This is a test for low emissions, showing compliance with emission requirements of all relevant European specifications. The even higher level "Indoor Air Comfort Gold", valid for all PROJECT FLOORS products, additionally shows compliance with the specifications of all relevant voluntary labels.

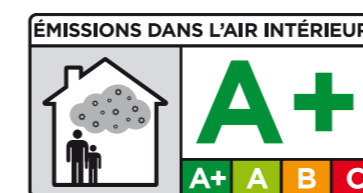

CO₂ Kompensation CO₂ compensation

Auch der Klimaschutz ist für PROJECT FLOORS eine wichtige Aufgabe, zu der wir unseren Beitrag leisten möchten. Dabei geht es einerseits darum, den CO₂ Ausstoß bestmöglich zu reduzieren. Beim Bau unserer Produktionsstätte wurden daher Photovoltaikanlagen mit einer Fläche von 7.200 qm installiert. Mittels Sonnenenergie kann somit ein Anteil von 14% des gesamten Energieverbrauchs gedeckt werden.

Auf der anderen Seite wollen wir das entstehende CO₂ für den Transport unserer Ware kompensieren. Regelmäßig ermitteln wir die Werte für den CO₂ Ausstoß beim Schiffs-, Straßen- und Zugverkehr. Das Prozedere hierzu ist von den unabhängigen Fachleuten von CO₂-Partner hinsichtlich Transparenz, Nachvollziehbarkeit, Genauigkeit und Vollständigkeit überprüft worden. Im gleichen Maße sorgen wir dann über die Non-Profit Organisation PRIMAKLIMA für eine Kompensation, indem wir verschiedene Projekte zur Wiederaufforstung, wie z.B. die von Regenwäldern im Amazonasbecken und im Kibale Nationalpark in Uganda, unterstützen.

PROJECT FLOORS considers climate protection to be a very important issue and strives to contribute in the best possible way. In order to reduce CO₂ emissions from our manufacturing, 7.200 sqm of photovoltaic panels were installed during the construction of our production facility. These solar panels now account for 14% of our overall energy consumption.

In order to offset the CO₂ emissions produced during the transportation of our floorings, we work closely with the experts at CO₂-Partner. Our procedure to regularly calculate the emissions for ship, road and rail transportation has been verified as transparent, authentic and accurate. We then compensate for these emissions by supporting various reforestation projects, such as those in the rain forests in the Amazon Basin and in Kibale National Park in Uganda, through the non-profit association PRIMAKLIMA.

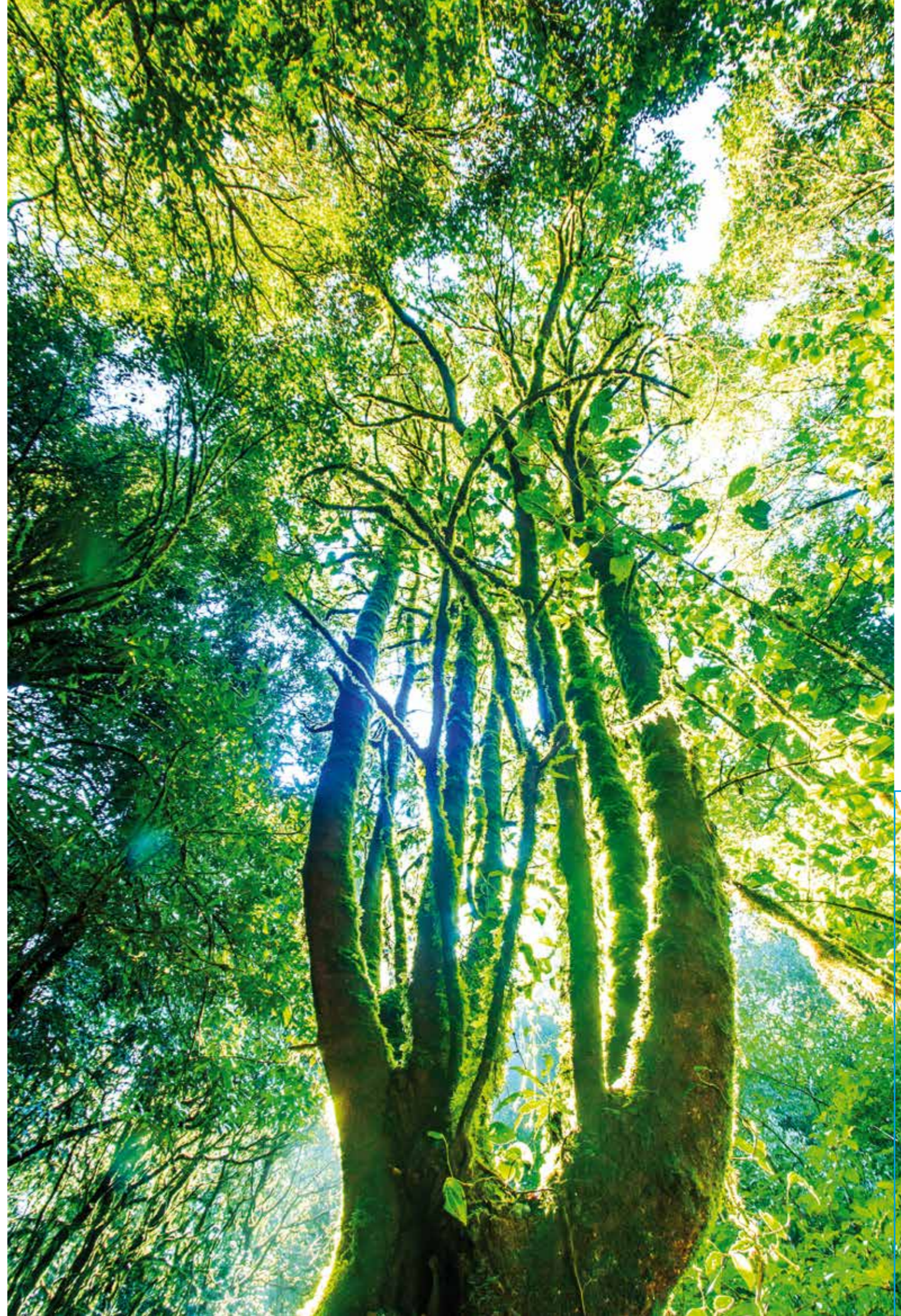

Zubehör Accessoires

Fugenprofile & Design-Fugenprofile Feature strips & Design strips

Zur Betonung der Einzelelemente oder zur Unterstreichung der natürlichen Optik lassen sich Fugenprofile und Design-Fugenprofile hervorragend einsetzen. In verschiedenen Farben und/oder Breiten findet sich zu jedem Boden der floors@work Kollektion die passende Ergänzung. Insbesondere bei einigen Steinoptiken empfehlen wir die Verwendung, um das Bild eines Natursteins mit Fuge zu perfektionieren.

To emphasise individual elements or the natural look, feature and design strips can be used to great effect. Different colours and/or widths have been specially chosen to work with all the designs in the floors@work collection. We especially recommend their use for some stone tiles to create an authentic look of natural stone with grouted joints.

Fugenprofile / Feature strips:
Abmessung / Dimension:
1000 x 3 x 2,3 mm
Verpackung / Packaging:
50 Stück / pieces per Röhre / tube

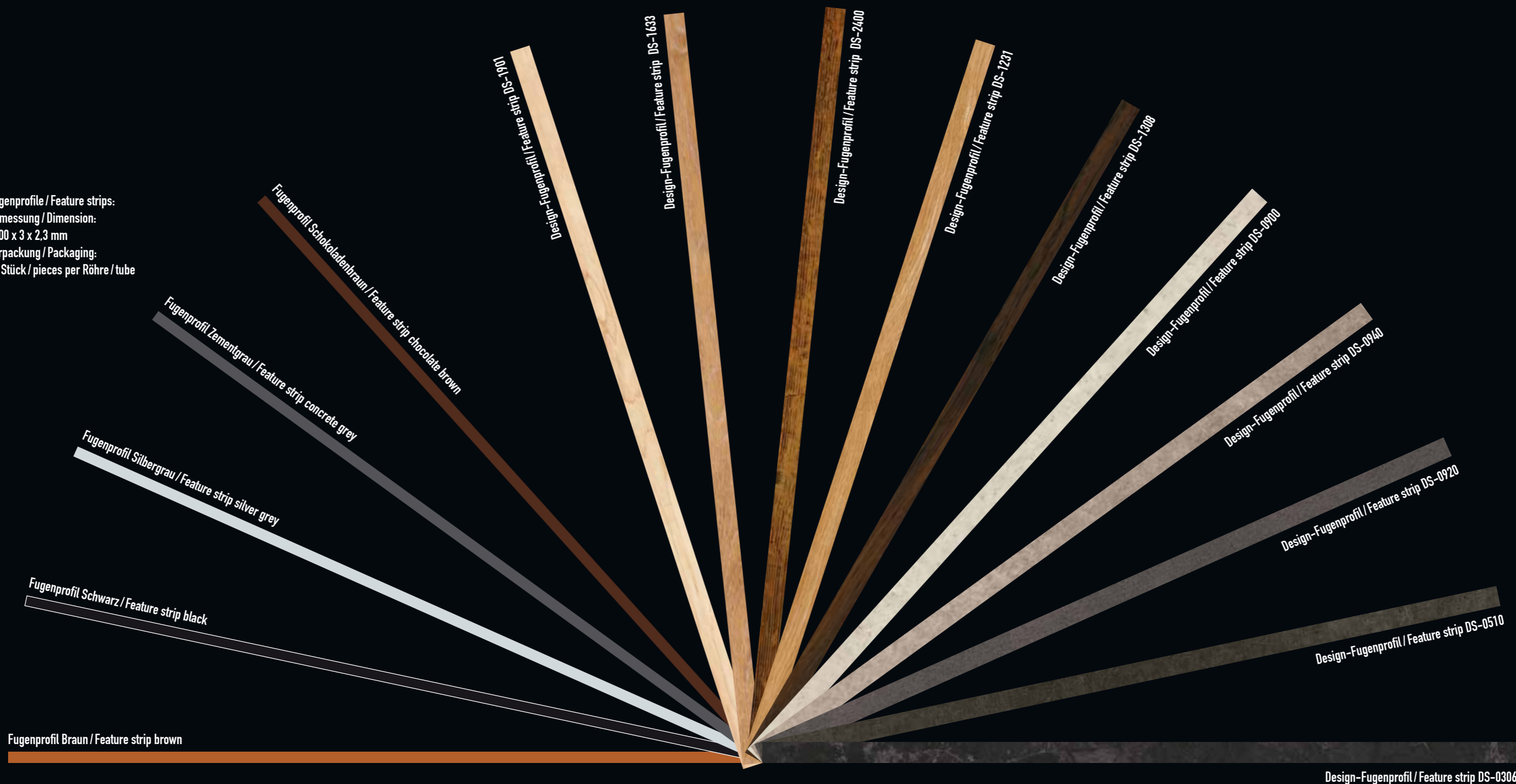

Breiten Design-Fugenprofile / Widths design strips:

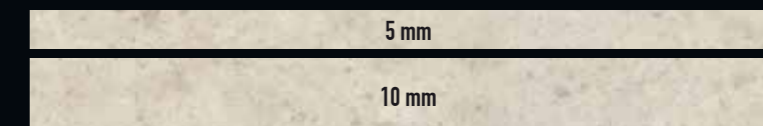

Design-Fugenprofile / Design strips:
Verfügbare Abmessungen:
914 x 5 x 2,3 mm und 914 x 10 x 2,3 mm
Verpackung: 25 Stück pro Karton

Available dimensions:
914 x 5 x 2,3 mm and 914 x 10 x 2,3 mm
Packaging: 25 pieces per box

Sockelleisten / Skirting Boards

Als perfekte Ergänzung zu seinen Designbodenbelägen bietet PROJECT FLOORS Ihnen designpassende Sockelleisten für eine Auswahl der Holzoptiken in der floors@work Kollektion an. Die innovative Haptronic-Oberfläche trägt zur authentischen Wahrnehmung des Dekors bei.

Die hochwertig verarbeiteten und leicht zu installierenden Sockelleisten werden ergänzt durch neutrale weiße Leisten in zwei verschiedenen Abmessungen und sind die beste Art, um Ihre persönliche Raumgestaltung passend abzurunden.

As the perfect compliment to our design floor coverings, PROJECT FLOORS offers you design fitting skirting boards for a selection of wood designs of the floors@work collection. The innovative Haptronic-Surface adds to the authentic perception of the design.

The high-quality products are easy to install and supplemented by plain white boards in two different dimensions. The best way to round off your personal interior design.

Weißer Sockelleisten White skirting boards

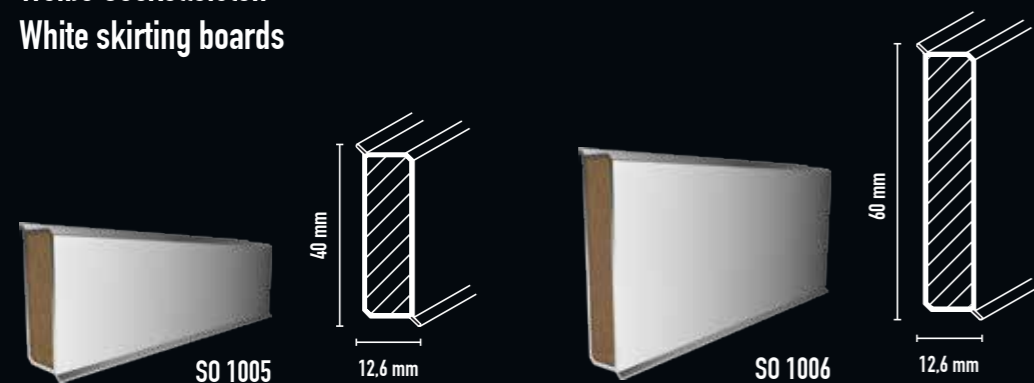

SO 1005: Abmessung / Dimension : 240 x 4 x 1,26 cm Verpackung / Packaging: 10 Stück / pieces per Bund / pack
 SO 1006: Abmessung / Dimension : 240 x 6 x 1,26 cm Verpackung / Packaging: 10 Stück / pieces per Bund / pack

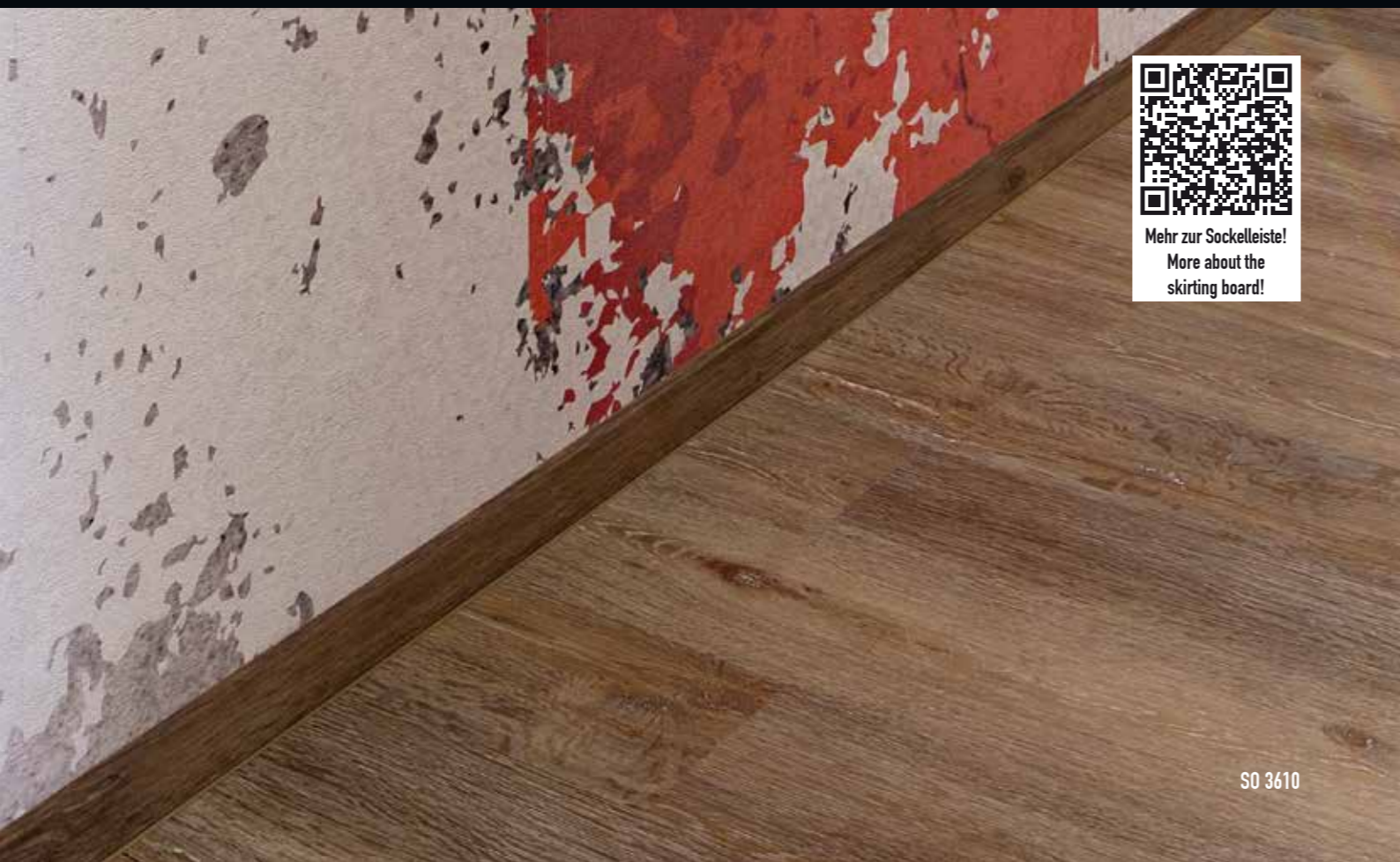

Mehr zur Sockelleiste!
More about the skirting board!

SO 3610

Abmessung / Dimension : 240 x 6 x 1,26 cm
 Verpackung / Packaging: 10 Stück / pieces per Bund / pack

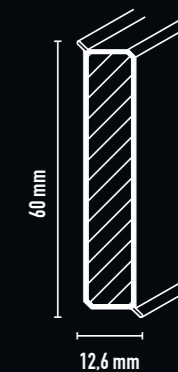



Umsetzung einer aufwendigen Logo-Intarsie
Implementation of an elaborate logo inlay

Intarsien Inlays

Ein weiterer Vorteil von Bodenbelag in Einzelementen sind die Gestaltungsmöglichkeiten mit Intarsien. Per Wasserstrahl exakt nach Ihren Vorgaben und Wünschen geschnitten, lassen sich aus allen Dekoren die verschiedensten Kreationen erstellen. Auch Schriftzüge oder Logos lassen sich perfekt in Ihren Boden integrieren. Sorgen Sie so für noch mehr Einzigartigkeit des Ambientes Ihrer Räumlichkeiten. Gerne beraten wir Sie bei der Auswahl der Dekore und visualisieren Ihnen einen Entwurf.

Another benefit of a floor created from individual tiles and planks is the added design option offered by inlays. Cut exactly to your specifications every plank or tile design can be used to create stunning inlaid designs. Even logos and text can be perfectly integrated into the floor. Designing with inlays offers you even more options to create a truly unique design for your space. We will happily assist you with the selection of designs to ensure your ideas become reality.

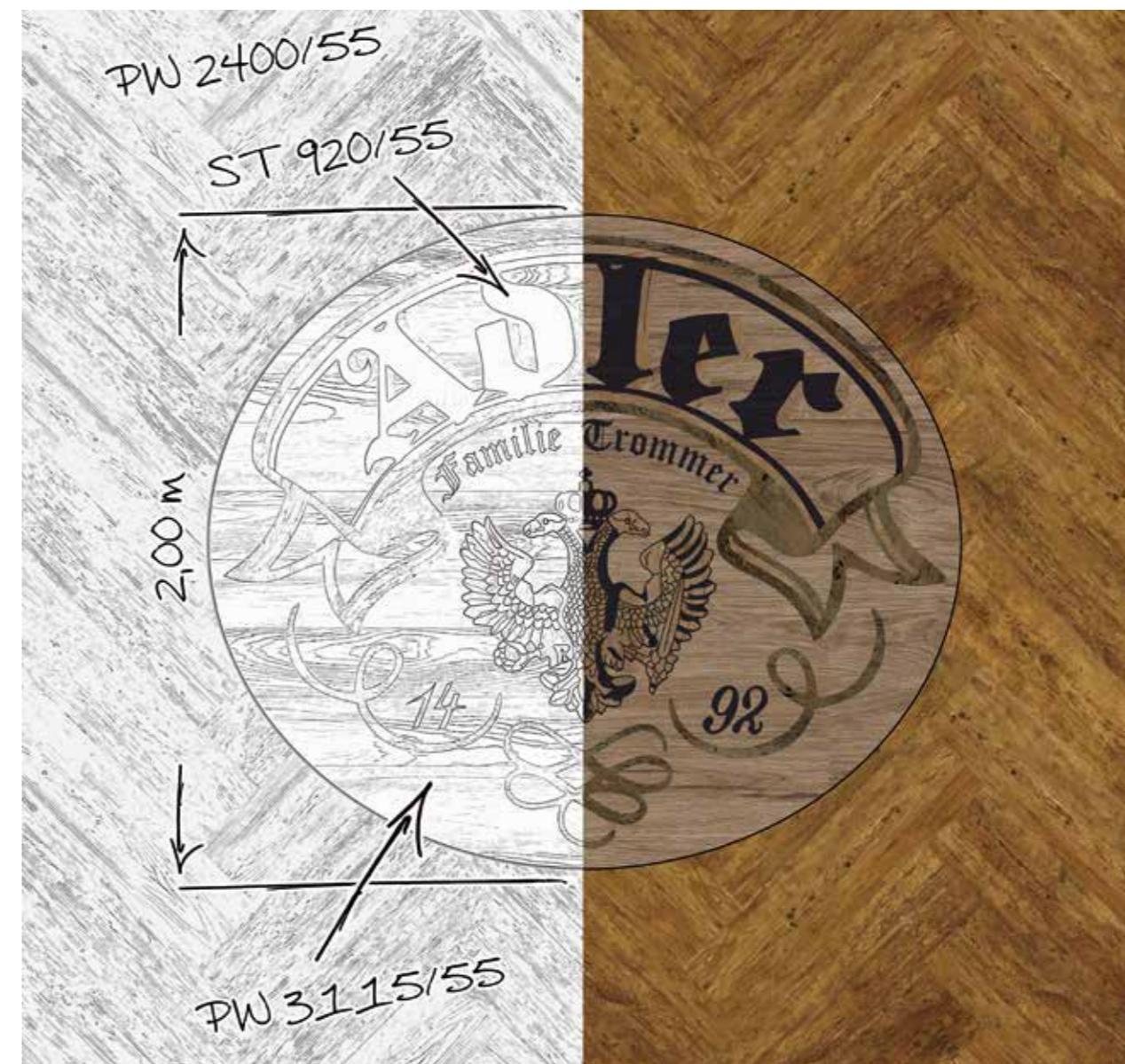



Logo-Intarsie mit Fliesendekoren
Logo inlay with tile designs



Logo-Intarsie mit Fliesen- und Holzdekoren
Logo inlay with tile and wood designs



Logo-Intarsie mit Holzdekoren
Logo inlay with wood designs



Bodengestaltung mit einer Intarsie in Lauboptik mit Holzdekoren
Floor design with a foliage inlay in wood designs



Wegweiser-Intarsie mit Holzdekoren
Signpost inlay with wood designs



Zimmernummer-Intarsie mit Holzdekoren
Room number inlay with wood designs

Technische Informationen

Technical information



Ihr Weg zu unserem
Web-Bodenstudio!
Your way to our
virtual floor studio!

Verlegearten Installation options

Durch die Lieferweise als Einzelemente ergeben sich zahlreiche Möglichkeiten bei der Verlegung. Ob gerade, quer oder diagonal, mit Fugenprofil oder Design-Fugenprofil – die Verlegeart gibt ihren Räumen das richtige Finish. Lange und schmale Räume werden optisch in die Breite gezogen, architektonische Linien in der Wandausrichtung werden aufgegriffen oder gebrochen, um eine ansprechende Gestaltung zu erzielen.

The delivery format of individual tiles and planks allows numerous options for installation. Straight laid, crossways or diagonal, with feature or design strips – each type of installation method can be adapted to your project for the ideal finish. Long and narrow rooms can appear wider, architectural lines of walls can be followed or broken to create balanced and complimentary interior designs.

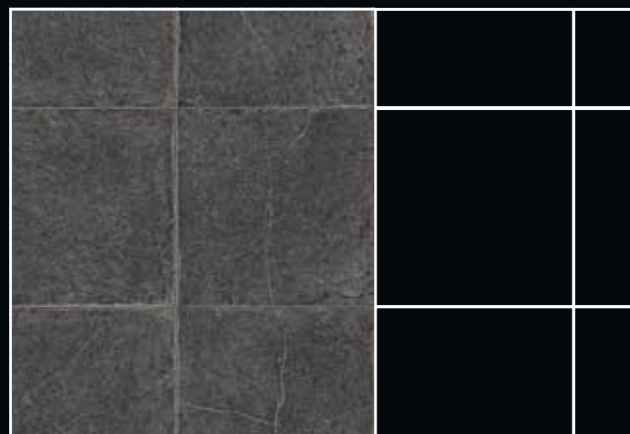

Gerade Verlegung Fliesen
Straight lay tiles

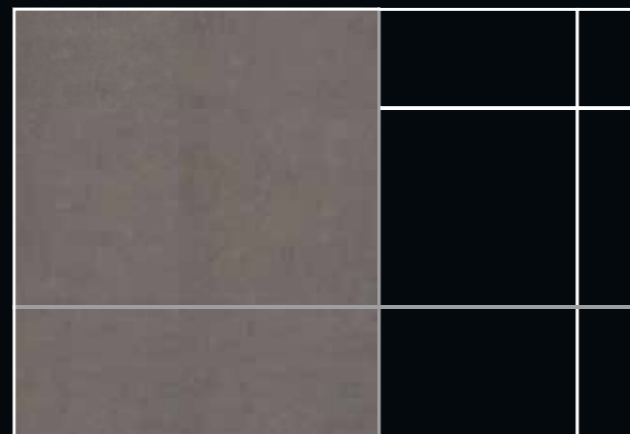

Gerade Verlegung, 4 Fliesen mit Fugenprofil eingefasst
Straight lay, 4 tiles with feature strip border



Regelmäßiger Verband
Regular formation



Verband-Verlegung mit Schlüsselsteinen
Tiles laid with key squares

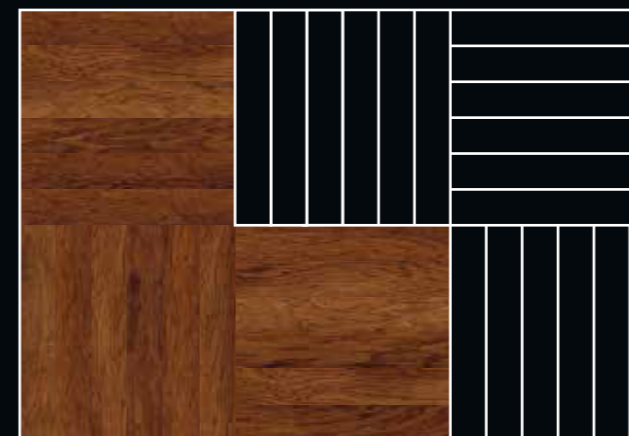

Holzblock-Verlegung
Woodblock



Leiterboden-Verlegung
Ladder pattern

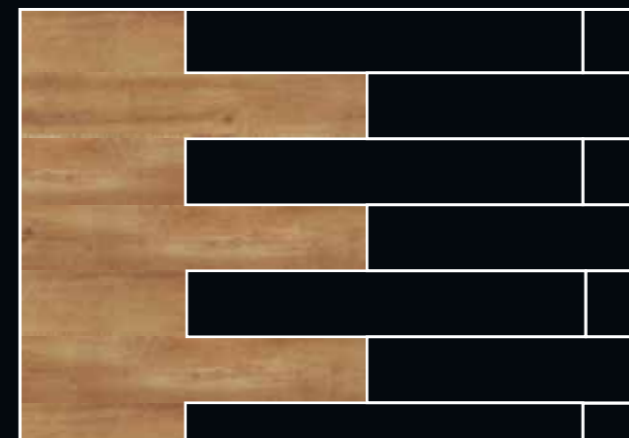

Gerade Verlegung
Straight lay



Unregelmäßiger Verband
Brick bond



Diagonale Verlegung
Diagonal lay

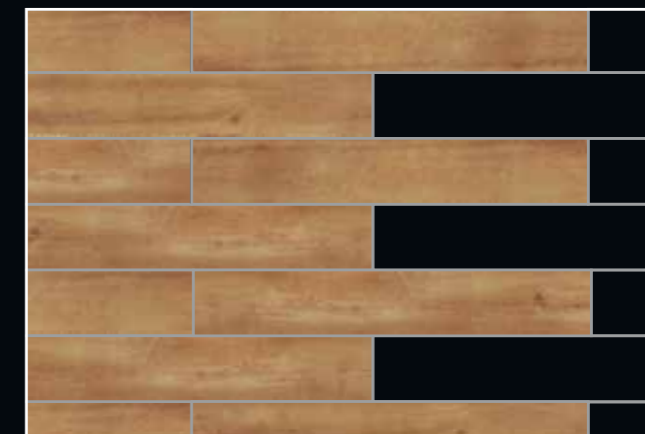

Gerade Verlegung mit Fugenprofilen längs und quer
Straight lay with feature strips all around

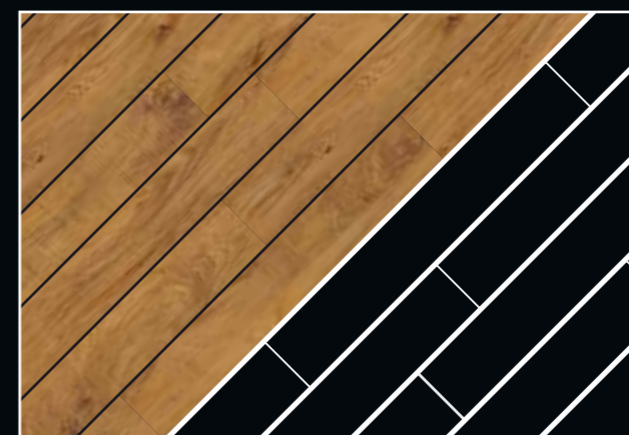

Schiffsdeck-Verlegung
Ships decking

 Technische Daten	floors@work/55
Belagsart nach EN ISO 10582	Heterogene Planken / Fliesen, Typ 1
Gesamtdicke ISO 24346	2,5 mm
Verpackungseinheit/Palette	3,34 m ² /200,40 m ² 600 x 600 mm: 3,24 m ² /194,40 m ²
Beanspruchungsklasse EN ISO 10582 / ISO 10874	23, 33, 42
Dicke der Nuttschicht ISO 24340	0,55 mm
Anzahl der Farben	60 Planken / 27 Fliesen
Angefaste Kanten	ja (dekorabhängig)
Flächengewicht ISO 23997	3,81 kg/m ²
Oberflächenvergütung	ja / PU
Resteindruck ISO 24343-1	≤ 0,1 mm*
Dimensionsstabilität ISO 23999	≤ 0,15 %*
Stuhlrollenbeanspruchung ISO 4918	geeignet bei Stuhlrollen gemäß EN 12529, Typ W
Fußbodenheizung	geeignet nach DIN EN 1264
Brandverhalten EN 13501-1	Bfl-s1
Wärmedurchlasswiderstand ISO 8302 / EN 12667	0,02 m ² K/W
Elektrostatisches Begehverhalten EN 1815	< 2 kV
Trittschallverbesserungsmaß ISO 10140-3	4 dB
Farbbeständigkeit gegenüber künstlichem Licht ISO 105-B02	≥ 7
Ableitwiderstand EN 1081	> 10 ¹² Ω
Chemikalienbeständigkeit ISO 26987	gegeben**
Rutsicherheit	R9 oder R10 (abhängig vom Dekor bzw. der Oberflächenprägung: Details auf Anfrage)
Reinigungs- und Pflegeempfehlung	Dr. Schutz

* Gemittelter Wert

** Bei kurzzeitiger Einwirkung von gebräuchlichen, haushaltsüblichen Mitteln.

Verlegung

1. Allgemeine Hinweise

Bitte überprüfen Sie die Ware hinsichtlich der gelieferten Menge und des bestellten Dekors. Vor der Verlegung sind alle Pakete auf Chargengleichheit und evtl. Mängel zu kontrollieren. Farbgleichheit der Ware wird nur bei Lieferung einer Anfertigung (Charge) gewährleistet. Wir bemühen uns, Ihnen chargengleiche Ware pro Lieferung zu senden. Bei evtl. Nachbestellung für ein Objekt bitte immer die Chargennummer angeben. Wenn es unser Lagerbestand ermöglicht, bekommen Sie chargengleiche Ware nachgeliefert bzw. werden Sie darüber informiert, dass eine Chargenabweichung vorliegt. Schadhafte oder fehlerhafte Planken sind vor der Verlegung auszusortieren und unter Angabe der Artikel- und Anfertigungsnummer zu reklamieren. Sichtbare Mängel können nach einer Verlegung nicht mehr anerkannt werden. Bei erkennbaren Mängeln kontaktieren Sie bitte sofort Ihren Lieferanten.

Bürostühle müssen für den Einsatz auf PROJECT FLOORS Bodenbelägen mit weichen Rollen Typ W nach DIN 68131 ausgestattet sein. Für zusätzlichen Schutz vor Verstrichungen und Kratzern durch bewegliche Möbelstücke sind nachträglich angebrachte Filzgleiter einzusetzen („scratchnomore“ von Dr. Schutz).

2. Untergrund

Geeignet sind alle Untergründe, die eben, sauber, trocken und rissfrei sind sowie nicht unter 15°C Oberflächentemperatur des Untergrunds liegen. Es gelten die nationalen Richtlinien und Normen sowie die anerkannten Regeln des Fachs. Zu beachten ist die VOB Teil C DIN 18365 Bodenbelagsarbeiten sowie die Mindestanforderungen an Estriche in DIN 18560. Weiterhin ist die DIN 18202, Toleranzen im Hochbau, einzuhalten. Bei beheizten Fußbodenkonstruktionen ist das Merkblatt des Zentralverbandes Sanitär-Heizung-Klima „Schnittstellenkoordinaten bei Fußbodenkonstruktionen“ sowie das Merkblatt des Zentralverbandes das Parkett und Fußbodentechnik zu erfüllen. Zu beachten ist die DIN EN1246-4:2001-12. Die Oberflächentemperatur sollte 18°C nicht übersteigen.

Die Oberflächentemperatur des Untergrunds sollte während der Verlegung bis 72 Stunden nach der Verlegung konstant sein, um ein ordentliches Abbinden des Klebstoffes zu gewährleisten. Des Weiteren zu beachten ist das BEB Merkblatt „Beurteilen und Vorbereiten von Untergründen, Verlegen von elastischen und textilen Belägen“.

Im Falle einer Verlegung auf einer zu erbringenden gespachtelten Fläche ist es empfehlenswert, den Untergrund mittels des Rakelverfahrens in Kombination mit der Stachel- oder Entlüftungswalze vorzubereiten/zu spachteln. Hinweise hierzu erhalten Sie direkt vom Hersteller der Spachtelmassen/Klebstoffe. Wir empfehlen dringend den kompletten bauchemischen Aufbau im System nach jeweiliger Herstellerempfehlung durchzuführen.

Als Untergrund ausgenommen sind alle textilen und feuchtigkeitsempfindlichen Beläge, PVC Beläge mit geschäumter Rückseite und Laminatfußböden. Generell ausgeschlossen werden Wintergärten sowie Bereiche, die möglicherweise unter starker Sonneneinstrahlung bzw. Hitze einwirkung stehen (ausgenommen sind Räumlichkeiten, die ganzjährig eine relativ konstante Temperatur +/- 5 Grad Celsius aufweisen). Eine Verlegung auf elektrobasierenden Fußbodenheizungssystemen wird nicht empfohlen, da hier die Heizkurve (Temperaturanstieg) zu schnell steigt. Durch PROJECT FLOORS nicht aufgeführte Untergründe bedürfen einer speziellen Freigabe. Das Verlegen auf nicht freigegebenen Untergründen kann im Reklamationsfall zum Ausschluss der Gewährleistung führen. Räder und Rollen auf Kautschukbasis (z.B. Autoreifen) können bei ständigem Kontakt mit den PROJECT FLOORS Produkten irreparable Farbveränderungen hervorrufen.

3. Akklimatisierung

Der Bodenbelag muss mindestens 48 Stunden vor der Durchführung der Verlegung in den zu verlegenden Räumen akklimatisiert werden. Die Akklimatisierung darf nicht auf der Palette, sondern muss in möglichst kleinen Stapeln, max. 4-5 Pakete, ca. 50 cm von einer Wand entfernt erfolgen. Pakete dürfen niemals stehend gelagert werden.

Folgende raumklimatischen Voraussetzungen sind 48 Stunden vor, während und 72 Stunden nach der Verlegung unbedingt einzuhalten: PROJECT FLOORS Dryback Designbodenbeläge sind bei einer Raumtemperatur von min. 18°C, einer Bodentemperatur von über 15°C und einer relativen Luftfeuchtigkeit von max. 75% zu verlegen. Eine Akklimatisierung darf nicht im direkten Sonnenlicht erfolgen.

4. Verlegung

Für eine optimale Flächenaufteilung werden die Räume ausgemessen und mit Hilfe eines Schnurschlags eingeteilt. PROJECT FLOORS Bodenbeläge müssen mit Dispersionsklebstoff im Nassklebverfahrenden auf saugfähigen Untergründen vollflächig verklebt werden. Bitte beachten Sie hierzu unsere aktuellen Klebstoffempfehlungen. Besondere bauseits bedingte Gegebenheiten (z.B. starke Sonneneinstrahlung, erhöhte Feuchtigkeitsbeaufschlagung) bedürfen einer individuellen Vorgehensweise bei der Verlegung. Hierzu finden Sie Informationen auf unserer Internetseite oder sprechen Sie mit unserer Anwendungstechnik. Die Vorgaben der Klebstoffhersteller z.B. im Hinblick auf Menge, Abluftzeit, etc. sind zwingend zu beachten. Bei Verwendung eines anderen Klebstoffs ist unbedingt unsere Freigabe sowie die Freigabe des Klebstoffherstellers schriftlich einzuholen.

5. Besonderheiten bei Fischgrät- und Chevron-Planken

Die Verlegung von Fischgrätplanken (mit der Verlegeart Fischgrät, Leiterverband oder Holzblock) oder Chevron erfordert ein erhöhtes Maß an Aufmerksamkeit und Vorbereitung, um ein gelungenes Ergebnis zu erzielen. Wir möchten Ihnen einige Hinweise geben, die Ihnen die Ausführung Ihrer Arbeit erleichtern soll:

Bei der Verlegung im Fischgrät-Verband:

Beim Anlegen des 90° Winkels während der Verlegung muss darauf geachtet werden, dass dieser exakt im Maß ist. Kleinste Abweichungen werden sich im Verlauf der Verlegung als Fugen darstellen:

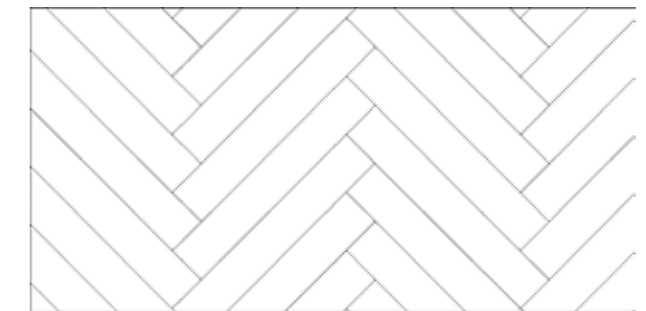

Bei der Verlegung im Chevron-Verband:

Beim Anlegen der ersten Reihe hilft Ihnen eine rostfreie Schneideschiene/ Stahlband. Hierbei muss darauf geachtet werden, dass diese exakt im Maß ist. Kleinste Abweichungen werden sich im Verlauf der Verlegung als Fugen darstellen.

Des Weiteren handelt es sich bei der Chevron Kollektion um zwei verschiedene Stäbe (linke & rechte Stäbe), diese sind wie folgt zu erkennen:

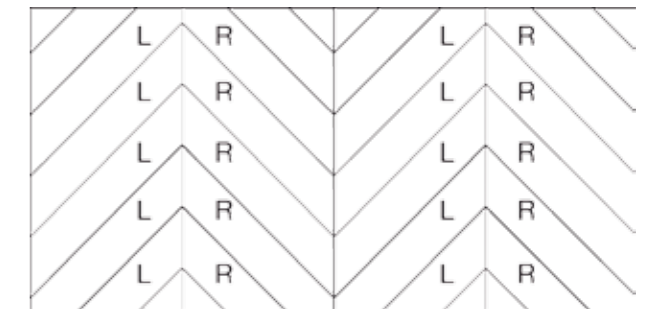

Die Stäbe müssen bei der Verlegung von einer zu anderen Seite abwechselnd verlegt werden.

Unsere Produkte werden einer strengen Qualitätskontrolle unterzogen, dennoch kann es vorkommen, dass sich im Kantenbereich ein Überstand gebildet hat. Dieser ist unbedingt vor dem Einlegen ins Klebstoffbett zu entfernen, um ein sauberes Anlegen der Planken zu gewährleisten.



Reinigung und Pflege

1. Allgemeine Hinweise

Bei den PROJECT FLOORS Designbodenbelägen handelt es sich um Produkte, welche bereits mit einer werkseitig aufgetragenen PU-Beschichtung ausgestattet sind.

Um langfristig ein optimales Erscheinungsbild sowie eine lange Lebensdauer zu gewährleisten, ist eine regelmäßige Reinigung notwendig. Diese richtet sich nach Frequentierung und Einsatzbereich sowie der Farbwahl und Oberflächenprägung des Dekors. Eine Veredelung der Nutzschrift mittels eines 2K-PU Siegelsystems ist auf Wunsch möglich. In besonderen Objektsituationen ist eine zusätzliche Beschichtung sinnvoll (siehe Punkt 7 „Wichtige Informationen“).

2. Vorbeugende Maßnahmen

Um den Belag vor mechanischen Beschädigungen durch den Schmutzeintrag von Wasser, Sand o.ä. zu schützen, empfiehlt es sich, geeignete Sauberlaufzonen einzurichten. Während der Bauphase ist es erforderlich, den Belag gegen mechanische Beschädigung durch andere Gewerke zu schützen.

3. Bauschlussreinigung

Nach Fertigstellung der Fläche ist eine Bauschlussreinigung notwendig, um vorhandenen Bauschmutz sowie Klebstoffreste vollständig zu entfernen. Sie ist nicht gleichzusetzen mit einer Grundreinigung (siehe Punkt 6).

Nach vom Hersteller vorgegebener Abtrocknungszeit des Klebstoffes ist der Bodenbelag mit PU-Reiniger (nicht Grundreiniger), verdünnt mit Wasser (gemäß Herstellerangaben), zu reinigen. Die Schmutzflotte muss vollständig aufgenommen und der Boden anschließend mit ausreichend klarem Wasser neutralisiert werden. Die Bauschlussreinigung dient nicht als vorbereitende Maßnahme, um anschließend eine Einpflege (siehe Punkt 4) durchzuführen! Hierzu ist eine Grundreinigung (siehe Punkt 6) erforderlich.

4. Einpflege

Aufgrund der bereits vorhandenen Oberflächenvergütung ist eine Ersteinpflege nicht zwingend erforderlich. Sofern die Trocknungszeiten der eingesetzten Klebstoffe berücksichtigt worden sind, kann die verlegte Fläche sofort begangen werden.

Je nach Einsatzbereich und der zu erwartenden Frequentierung kann auf Wunsch ein hochwertiges PU-Siegelsystem der Firma Dr. Schutz appliziert werden. Hierbei erhält der Bodenbelag einen zusätzlichen Schutz vor den mechanischen Einflüssen des täglichen Gebrauchs. Gerne beraten wir Sie auch individuell je nach Einsatzbereich – bitte sprechen Sie uns an!

5. Laufende Reinigung und Unterhaltspflege

Unter der laufenden Unterhaltspflege versteht man eine manuelle Reinigung, welche unter Einsatz üblicher Wischgeräte durchgeführt wird. Zuerst wird der Grobschmutz mittels Besen bzw. Staubsauger entfernt. Anschließend wird die Fläche mit dem PU-Reiniger nebelfeucht entsprechend der Gebrauchsanweisung gewischt. Hier empfiehlt sich das Spray-Mop Set von Dr. Schutz.

6. Grundreinigung

Je nach Verschmutzungsgrad kann der Fußboden in größeren Zeitabständen mit dem Grundreiniger R (Dr. Schutz) verdünnt gemäß Herstellerangaben gereinigt werden. Nach vollständiger Aufnahme der Schmutzflotte wird der Belag mit klarem, warmem Wasser neutralisiert, bis alle Schmutz- und Reinigungsreste vollständig beseitigt sind. Anschließend kann auf Wunsch eine Einpflege (siehe Punkt 4) vorgenommen werden. Bei größeren Flächen empfiehlt sich der Einsatz von Reinigungs- und Pflegemaschinen.

Sollten Pflegeprodukte anderer Hersteller eingesetzt werden, so ist dies mit den jeweiligen Pflegemittelherstellern abzustimmen. Sollten Sie noch weitere Fragen zur richtigen Reinigung und Pflege von Bodenbelägen haben, wenden Sie sich bitte an den Beratungsdienst von Dr. Schutz, Bonn Tel.: +49 228 95352 0, Fax: +49 228 95352 28 oder unter www.dr-schutz.com.

Durch Weitergabe dieser Reinigungs- und Pflegeanleitung erfüllt der Bodenleger seine Pflicht gemäß DIN 18365. Die jeweils aktuellsten Informationen zu Reinigung und Pflege finden Sie auf www.project-floors.com im Bereich „Downloads“.

7. Wichtige Informationen

Ladenlokale, Laufzonen:

In Zonen mit zu erwartender erhöhter Frequentierung empfehlen wir, vor der ersten Nutzung ein geeignetes PU-Siegelsystem aufzubringen.

Friseursalons, Autohäuser:

Es wird das fleck- und farbstoffresistente PU-Siegelsystem „Anti-Color“ der Firma Dr. Schutz empfohlen, um Verfärbungen sowie Weichmacherwanderungen entgegen zu wirken.

Gesundheitswesen:

In allen Bereichen, in denen Hand- und Flächendesinfektionsmittel zum Einsatz kommen, empfehlen wir den Einsatz des PU-Siegelsystems. Hiermit erhält der Belag einen optimalen Langzeitschutz und beugt der eventuellen Verfärbung durch die Desinfektionsmittel vor.

Werterhaltung:

PROJECT FLOORS Beläge können generell jederzeit mit dem PU-Siegelsystem nachveredelt / aufgefrischt werden, wenn durch mechanische Beanspruchung Gebrauchsspuren vorhanden sind, die mittels täglicher Pflege nicht mehr zu beseitigen sind.

Für zusätzlichen Schutz vor Verstrichungen und Kratzern durch bewegliche Möbelstücke sind nachträglich angebrachte Filzgleiter vorausgesetzt. Bürostühle müssen für den Einsatz auf PROJECT FLOORS Bodenbelägen mit weichen Doppel-Lenkrollen Typ W (weich) nach DIN 68131 ausgestattet sein.



Mehr zum Design!
More about the design!

floors@work/55	
Luxury, high performance PVC-floor covering for high commercial and heavy duty residential applications.	
Covering type according to EN ISO 10582	Heterogeneous Planks / Tiles, Type 1
Total thickness ISO 24346	2.5 mm
Packaging per box/pallet	3.34 m ² /200.40 m ² 600 x 600 mm: 3.24 m ² /194.40 m ²
Performance classification EN ISO 10582 / ISO 10874	23, 33, 42
Wearlayer thickness ISO 24340	0.55 mm
Number of colours	60 planks / 27 tiles
Bevelled edges	yes (depending on design)
Total weight ISO 23997	3.81 kg/m ²
Surface treatment	yes / PU
Residual indentation ISO 24343-1	≤ 0.1 mm*
Dimensional stability ISO 23999	≤ 0.15 %*
Castor chair suitability ISO 4918	yes – using wheels in accordance with EN 12529, Type W
Underfloor heating	suitable according to DIN EN 1264
Behaviour to fire EN 13501-1	Bfl-s1
Resistance to thermal conductivity ISO 8302 / EN 12667	0.02 m ² K/W
Electrical propensity when walked upon EN 1815	< 2 k/V
Impact sound improvement ISO 10140-3	4 dB
Colour fastness to artificial light ISO 105-B02/2	≥ 7
Electrostatic characteristics EN 1081	> 10 ¹² Ω
Chemical resistance ISO 26987	conforms**
Slip resistance	R9 or R10 (depending on design resp. emboss; details available on request)
Maintenance/Cleaning recommendations	Dr. Schutz

* Averaged value

** Vis-à-vis the short-term effects of normal, domestic agents.

Installation

1. General instructions

Please inspect the goods with respect to the quantity supplied and the design variant ordered. All packages are to be inspected for batch uniformity and any defects prior to commencing the laying process. The colour consistency of the goods is guaranteed only upon the supply of fabricated items (batch). In each consignment, we endeavour to send you uniform goods. Should subsequent orders be placed for an item, please always specify the batch number. If our stocks permit, you will receive uniform goods in a subsequent shipment or you will be informed that there is a batch-specific deviation. Damaged or defective planks are to be sorted and notification thereof provided immediately, duly specifying the item number and the batch number. Visible defects can no longer be admitted once the flooring has been laid. In the event of noticeable defects, please contact your supplier immediately.

Office chairs that are to be used with PROJECT FLOORS floor coverings must be equipped with type W soft castors conforming to DIN 68131. Affix felt pads such as Dr. Schutz's scratchnomore to provide extra protection against score marks and scratches from movable furniture.

2. Substrate

Suitable substrates are all surfaces which are flat, clean and free of grease, fat and cracks, and which have a surface temperature no lower than 15°C. National guidelines and standards and recognized rules of the trade apply. You must conform to German Construction Contract Procedures (VOB) Part C DIN 18365 Flooring works and the minimum requirements for screed in DIN 18560. You must also comply with DIN 18202. Tolerances in building construction. If heated flooring is being installed, you must meet the requirements in the German Central Association for Plumbing, Central Heating and Air Conditioning (ZVSHK) Code of Practice „Interface coordinates in flooring structures“ and in the German Parquet and Flooring Technology (ZVPF) Code of Practice. You must observe DIN EN1246-4:2001-12. The surface temperature should not exceed 18°C. During laying, the sub-surface temperature should remain constant for 72 hours after the floor is fitted to ensure that the adhesive bonds properly. You also need to observe the German Federal Association of Screed and Floor Covering's (BEB) Code of Practice „Assessing and preparing sub-surfaces, laying elastic and textile floorings“.

If you are fitting the flooring on a surface to be treated with filler, it is recommended to prepare/fill the surface using a squeegee and a spike-tooth or deaeration roller. You can obtain the instructions directly from the filler/adhesive manufacturer. We recommend carrying out the entire construction chemical process systematically as per the manufacturer's recommendations.

Not suitable as substrate are any textile or moisture-sensitive floorings, PVC floorings with foamed rear and laminate floorings. As a general rule, floorings must not be laid in conservatories or areas which may be exposed to strong sunlight or heat (except rooms which have a relatively constant temperature +/- 5 degrees Celsius the whole year). It is not recommended to lay floorings on electric floor heating systems since the heating temperature rises too quickly.

Any substrates not laid by PROJECT FLOORS require special approval. Laying flooring on non-approved substrates may void the warranty in the event of a claim in such cases. Rubber-based castors and wheels, such as car tyres, may cause irreversible discolouration in the event of constant contact with the PROJECT FLOORS products.

3. Acclimatisation

The flooring must be left to acclimatise in the rooms where it will be laid for at least 48 hours before it is fitted. Do not leave the flooring on the pallet. Instead, make stacks of max. 45 packages which are as small as possible about 50 cm away from a wall. Packages must never be stored in a vertical position.

You must meet the following indoor climate conditions for 48 hours before and while the floor is being laid and for 72 hours after it is fitted: PROJECT FLOORS Dryback design floorings must be laid at a min. room temperature of 18 °C, a floor temperature of over 15 °C and a max. relative humidity of 75%. Flooring must not acclimatise in direct sunlight.

4. Installation

Rooms should be measured and divided up with a chalk line to ensure optimum division of space. PROJECT FLOORS floorings must be affixed onto absorbent substrates with dispersion adhesive applied across their whole surface using the wet adhesive bed process. Observe our current recommendations on adhesive usage. Special conditions on site, such as strong sunlight and high moisture levels, require a specifically adapted approach to fitting boards. You will find more information on this aspect on our website or you can contact our Application Engineering Department. You must observe the adhesive manufacturer's instructions with regard to aspects such as quantity and airing time. If you use a different adhesive, you must obtain our approval and approval from the manufacturer in writing.

5. Special advise for our herringbone and Chevron planks

Fitting herringbone planks using the herringbone, ladder pattern or Chevron requires great care and preparation to ensure an accomplished result. We'd like to give you a few tips to make it easier to lay boards:

When fitting boards in a herringbone pattern:

You must ensure that angle measurements are exact when laying boards at 90°. Even the tiniest deviations will leave gaps as you fit boards:



When laying boards in a chevron pattern:

Use a rust-free cutting ruler/steel strip to help lay the first row. You must ensure the first row is measured precisely. Even the tiniest deviations will leave gaps as you fit boards.

The Chevron Collection also contains two different slat types: a right-hand one and a left-hand one. You can distinguish between them as follows:

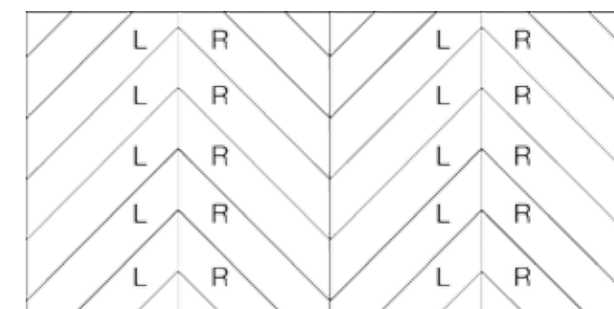

You must switch from side to side as you fit them and work your way up.

Our products undergo stringent quality controls however there may occasionally be a slight burr at the edges as a result of the manufacturing process. This needs to be removed before the plank is laid to ensure a perfectly aligned installation.



Cleaning and Care

1. General information

PROJECT FLOORS Design Flooring provides products with a polyurethane coating already applied at factory level. Regular cleaning is necessary to maintain the optimal appearance of our products over the long term and to ensure a long life. This will depend on the area of application and how often it is frequented, as well as on the choice of colour and the surface embossing of the decor. A refinement of the wear layer by means of a 2-component sealing system is available on request. The application of an additional coating is a useful option in certain situations (see point 7 "Important information").

2. Preventative measures

In order to protect the flooring from mechanical damage caused by the introduction of dirt, water, sand, etc., it is advisable to establish appropriate clean-off zones. During the construction phase, it is necessary to protect the flooring from mechanical damage caused by other trades.

3. Cleaning on completion of construction work

Once construction work is complete, it is necessary to clean the work area to ensure that any building waste and adhesive residue is completely removed. This process is not the same as basic cleaning (see point 6). In accordance with the adhesive drying times specified by the manufacturer, the floor covering must be cleaned by using PU cleaner (not basic cleaner) diluted with water (according manufacturer recommendation). The waste cleaning water must be completely absorbed and the floor then neutralised with adequate amounts of clear water. The process of cleaning on completion of construction work does not serve as a preparatory measure for an initial treatment (see point 4)! For this process, basic cleaning is required (see point 6).

4. Initial treatment

Because the surface coating has already been applied, an initial treatment is not absolutely necessary. As long as the drying times of the adhesive are respected, the laid area can be walked on immediately. Depending on the area of application and how often it is frequented, a high-grade PU sealing system produced by the company Dr. Schutz can be applied. In this case, the flooring is provided with protection against the mechanical effects of daily use. We are happy to advise you personally about your particular area of use – please contact us!

5. Day-to-day cleaning and maintenance care

Day-to-day cleaning in this case means manual cleaning using a conventional mop. The coarse dirt must firstly however be removed by means of a broom or vacuum cleaner. The area can then be damp-wiped with a PU cleaner in accordance with the instructions provided.

6. Basic cleaning

Depending how dirty it is, the floor can be cleaned intermittently with the basic cleaner R (Dr. Schutz), which must be diluted in accordance with the manufacturer's recommendations. Once the waste cleaning water has been completely absorbed, the flooring is neutralised with clear, warm water until all dirt and cleaning residue have been completely removed. Following this procedure, an initial treatment can be carried out if desired (see point 4). In the case of larger areas, the use of cleaning and treatment machines is recommended.

If treatment products from another manufacturer are used, their application must be in line with the advice of that particular manufacturer. If you have any further questions concerning the cleaning and care of flooring, please contact customer service at Dr. Schutz, Bonn Tel.: +49 228 95352 0, Fax: +49 228 95352 28 or look online at www.dr-schutz.com.

By providing these cleaning and care instructions, the floor layer fulfils his obligations in accordance with DIN 18365. You can find the latest information about cleaning and care at www.project-floors.com in the „Downloads“ section.

7. Important information

Shops, walkways:

In areas which are expected to be frequented to a higher degree, we recommend that an appropriate PU sealing system is applied before the flooring is first used.

Hairdressing salons, car dealerships:

For applications in these areas, we recommend the stain and dye resistant PU sealing system „Anti-Color“, produced by the company Dr. Schutz, as it counteracts changes in colouration and plasticity.

Health considerations:

In all areas in which hand and surface disinfectants are used, we recommend the use of the PU sealing system, as the flooring is provided with optimal longterm protection and the possibility of discolouration through the use of disinfectant is prevented.

Conservation of value:

If signs of wear caused by mechanical demands have become apparent, and these cannot be removed by means of daily care and treatment, PROJECT FLOORS floor coverings can generally be upgraded or refreshed at any time by the application of the PU sealing system.

For additional protection from scuffing and scratches caused by the movement of furniture, the use of felt pads is required. Office chairs intended for use on PROJECT FLOORS floor coverings must be fitted with soft double castors type W (soft), in accordance with DIN 68131.



Mehr zum Design!
More about the design!



Type de revêtement selon EN ISO 10582	Hétérogène planches / carreaux, Type 1
Épaisseur totale ISO 24346	2,5 mm
Unité d'emballage/palette	3,34 m ² /200,40 m ² 600 x 600 mm: 3,24 m ² /194,40 m ²
Classe d'intensité d'usage EN ISO 10582 / ISO 10874	23, 33, 42
Épaisseur de la couche d'usure ISO 24340	0,55 mm
Nombre de coloris	60 planches / 27 carreaux
Bords chanfreinés	oui (selon le dessin)
Poids total ISO 23997	3,81 kg/m ²
Traitement de surface	oui / PU
Poinçonnement résiduel ISO 24343-1	≤ 0,1 mm*
Stabilité dimensionnelle ISO 23999	≤ 0,15 %*
Résistance aux sièges à roulettes ISO 4918	adapté aux sièges à roulettes suiv. EN 12529, type W
Chauffage au sol	adapté à la norme DIN EN 1264
Comportement au feu EN 13501-1	Bfl-s1
Résistance à la conductibilité thermique ISO 8302 / EN 12667	0,02 m ² K/W
Comportement électrostatique pendant la marche EN 1815	< 2 k/V
Amélioration du bruit d'impact ISO 10140-3	4 dB
Tenue à la lumière artificielle ISO 105-B02/2	≥ 7
Résistance électrique EN 1081	> 10 ¹² Ω
Résistance aux substances chimiques ISO 26987	résistant**
Résistance au glissement	R9 jusqu'à R10 (selon le dessin)
Conseil de nettoyage et d'entretien	Dr. Schutz

* Valeur moyenne

** Lors d'une durée de contact courte de produits courants.

Instructions de pose

1. Remarques générales

Veillez vérifier la quantité de la marchandise livrée et le décor commandé. Veillez vérifier avant la pose l'homogénéité de charge et l'absence de défauts de tous les paquets avant la pose. L'homogénéité chromatique de la marchandise n'est garantie que lors de la livraison d'un lot de fabrication (charge). Nous nous efforçons de vous fournir une marchandise avec une charge homogène à chaque livraison. En cas d'éventuelle commande ultérieure, veuillez toujours indiquer le numéro de charge de l'objet. Si notre stock le permet, vous recevrez alors une marchandise avec une charge homogène ou serez informé(e) en cas d'écart de charge. Il convient de trier avant la pose les planches défectueuses ou endommagées et de faire une réclamation en mentionnant le numéro d'article et de fabrication. Des défauts visibles ne peuvent plus être identifiés après la pose. En cas de défauts reconnaissables, veuillez immédiatement contacter votre fournisseur. Les sièges de bureau doivent être équipés de roulettes souples de type W conformes à la norme DIN 68131 en cas d'utilisation sur des revêtements de sol PROJECT FLOORS. Prévoir la pose ultérieure de patins en feutre (« scratchnomore » de Dr. Schutz) pour assurer une protection supplémentaire contre les traînées et les éraflures dus aux déplacements de meubles.

2. Support

Convient tous les supports plans, propres, secs, exempts de graisses et de fissures et dont la température est au moins égale à la température de surface de 15 °C du support. Les prescriptions et normes nationales, ainsi que les règles reconnues de la discipline s'appliquent. Il convient de respecter les VOB – partie C – DIN 18365 Travaux de revêtement de sol, mais aussi les exigences minimales relatives aux chapes dans DIN 18560. La norme DIN 18202, Tolérances pour la construction de bâtiments, doit aussi être respectée. Dans le cas de planchers avec chauffage par le sol, il convient de respecter la notice de la Confédération nationale du sanitaire, du chauffage et de la climatisation « Coordination d'interfaces pour constructions de planchers », ainsi que celle de la Confédération allemande des techniques de parquets et revêtements de sol. La norme DIN EN1246-4:2001-12 doit être respectée. La température de surface ne doit pas dépasser 18°C. La température de surface du support devrait rester constante durant la pose et jusqu'à 72 heures après pour garantir une adhérence parfaite de la colle. De plus, la notice BEB « Évaluation et préparation de supports, pose de revêtements élastiques et textiles » doit être respectée.

En cas de pose sur une surface spatulée, il est recommandé de préparer/boucher à la spatule le support au moyen d'un procédé de raclage avec le hérissou ou le rouleau en polypropylène. Vous trouverez des instructions correspondantes directement auprès du fabricant de masses de spatulage/colles. Nous recommandons la réalisation de toute urgence du complexe chimique complet dans le système d'après la recommandation du fabricant.

Sont exclus pour support tous les revêtements textiles et sensibles à l'humidité, ainsi que ceux en PVC avec partie arrière en mousse et les revêtements de sol laminés. D'une manière générale, sont exclus les jardins d'hiver, ainsi que les zones susceptibles d'être exposées à un rayonnement solaire important et à des chaleurs élevées (sont exclus les locaux dont la température constante relative est toute l'année de +/- 5°C). La pose sur des systèmes de chauffage électrique par le sol est déconseillée car la courbe de chauffage (élévation de température) est alors trop rapide.

Les supports non réalisés par PROJECT FLOORS nécessitent une réception spécifique. La pose sur des supports sans réception peut faire l'objet, en cas de réclamation, d'exclusion de tout recours en garantie. Les roues et roulettes en caoutchouc (par ex. pneus de voiture) peuvent être, en cas de contact permanent avec les produits PROJECT FLOORS, à l'origine de décolorations irréparables.

3. Acclimatation

Le revêtement de sol doit être climatisé au moins 48 heures avant les travaux de pose dans les pièces concernées par la pose. L'acclimatation doit se faire non pas sur la palette, mais en petits tas, 4-5 paquets max., à env. 50 cm d'une paroi. Les paquets ne doivent jamais être entreposés sur le chant.

Les conditions ambiantes suivantes doivent impérativement être respectées 48 heures avant, pendant et 72 heures après la pose :

Les revêtements de sol design PROJECT FLOORS Dryback doivent être posés à une température ambiante d'au moins 18°C, une température de sol supérieure à 15°C et avec une humidité relative de l'air maximale de 75%. L'acclimatation ne doit pas se faire sous exposition solaire directe.

4. Pose

Pour optimiser la répartition en surface, les pièces sont mesurées et divisées au moyen d'un cordeau. PROJECT FLOORS Les revêtements de sol doivent être recouverts sur toute leur surface de colles à dispersion selon le procédé de collage à l'état humide sur supports absorbants. Veuillez à ce sujet respecter nos actuelles recommandations de collage. En cas de conditions particulières côté construction (rayonnement solaire élevé, sollicitation par l'humidité importante, par ex.), il convient de prévoir une méthode de pose spécifique. Vous trouverez des informations à ce sujet sur notre site Internet ou bien auprès de nos techniciens d'application. Les prescriptions du fabricant de colles doivent être scrupuleusement respectées, notamment en matière de quantité, de durée de séchage, etc. L'utilisation d'une autre colle nécessite notre accord préalable, ainsi que

l'autorisation écrite du fabricant de colles.

5. Spécificités des planches en arêtes de poissons et chevron

La pose de planches à bâtons rompus selon le mode de pose en arêtes de poisson ou en chevron exige une grande attention et une préparation soignée pour atteindre un résultat satisfaisant. Nous souhaitons vous présenter quelques remarques pour faciliter la réalisation de votre travail :

Lors de la pose en arêtes de poisson :

en cas de pose selon un angle de 90°, il convient de veiller à ce que celui-ci soit exact en termes de dimensions. Des écarts infimes se manifesteraient sinon au niveau des joints en cours de pose :



Lors de la pose en chevron :

Une règle/bande métallique en inox facilite la pose de la première rangée. Il convient à cette occasion de s'assurer que ses dimensions sont exactes. Des écarts infimes se manifesteraient sinon au niveau des joints en cours de pose.

Dans le cas de la collection Chevron, il s'agit de deux barres différentes (barres gauche & droite) que l'on distingue comme suit :

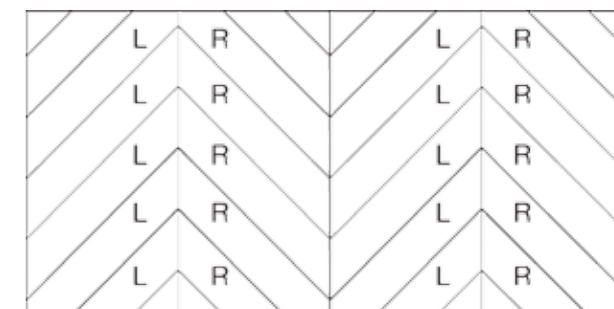

Lors de la pose, elles doivent être posées alternativement en passant d'un côté à l'autre.

Malgré des contrôles de qualité rigoureux de nos produits, un débord peut apparaître au niveau de l'arête. Celui-ci doit être supprimé avant la pose dans le lit de colle pour garantir une pose propre des planches.



Instructions de nettoyage et d'entretien

1. Généralités

Les revêtements de sol design PROJECT FLOORS sont enduits d'une couche de PU à l'usine. Un nettoyage régulier s'impose afin de maintenir à long terme leur aspect optimal et garantir une longévité élevée. Ce nettoyage varie en fonction de la fréquentation et du secteur d'utilisation ainsi que du coloris et du type de décor. Sur demande, il est possible de procéder à un finissage de la couche d'usure au moyen d'un vitrifiant PU à 2 composants. Dans certaines situations, il est judicieux d'opter pour un revêtement supplémentaire (voir Point 7 « Informations importantes »).

2. Mesures préventives

Pour protéger le revêtement de sol des dommages mécaniques dus à l'apport de saletés par l'eau, le sable, etc., il est conseillé d'aménager des zones de passage propre aux endroits appropriés. Pendant la phase de travaux, il est nécessaire de protéger le revêtement contre les dégâts mécaniques provoqués par les différents corps de métier.

3. Nettoyage final du chantier

Une fois les travaux achevés sur la surface concernée, il faut procéder au nettoyage final du chantier de manière à éliminer les salissures ainsi que les résidus de colle. Cette opération ne doit pas être confondue avec le nettoyage intensif (voir Point 6).

Après le temps de séchage prescrit par le fabricant de la colle, le revêtement de sol doit être nettoyé avec un nettoyeur PU (et non pas un agent de nettoyage intensif) dilué à l'eau (selon indications du constructeur). Tout le liquide sale doit être éliminé avant de neutraliser le sol à l'eau claire en quantité suffisante. Le nettoyage final du chantier ne sert pas de mesure préventive au premier entretien (voir Point 4). Pour ce faire, il est nécessaire d'effectuer un nettoyage intensif (voir Point 6).

4. Premier entretien

Grâce à la présence du traitement de surface, le premier entretien n'est pas absolument obligatoire. Dans la mesure où les temps de séchage des colles utilisées ont été respectés, la surface posée est immédiatement praticable.

En fonction du secteur d'utilisation et de la fréquentation prévue, il est possible d'appliquer sur demande un vitrifiant PU de qualité supérieure de la société Dr. Schutz. Le revêtement de sol bénéficie alors d'une protection supplémentaire contre les influences mécaniques de l'utilisation quotidienne.

Nous sommes à votre disposition pour vous conseiller personnellement en fonction du secteur d'utilisation concerné – N'hésitez pas à nous contacter !

5. Nettoyage et entretien réguliers

On entend par entretien régulier une opération manuelle faisant appel aux auxiliaires d'essuyage courants. Commencer par enlever les salissures grossières à l'aide d'un balai ou d'un aspirateur. Puis traiter la surface avec un nettoyeur PU en suivant les instructions d'emploi.

6. Nettoyage intensif

Selon le degré de salissure, le sol peut être nettoyé à intervalles plus longs avec le nettoyeur intensif R (Dr. Schutz) dilué selon les indications du fabricant. Après avoir entièrement récupéré la saleté, il faut neutraliser le revêtement avec de l'eau propre et chaude jusqu'à l'élimination complète de tous les résidus de saleté et de nettoyage. Si souhaité, il est ensuite possible de réaliser un premier entretien (voir Point 4). Sur une grande surface, il est recommandé d'utiliser des machines de nettoyage et d'entretien.

En cas d'utilisation d'autres produits d'entretien, en convenir au préalable avec le fabricant du produit concerné. Si vous avez encore des questions relatives au nettoyage et à l'entretien corrects des revêtements de sol, veuillez vous adresser aux conseillers de Dr. Schutz, Bonn Tél. : +49 228 95352 0, Fax : +49 228 95352 28 ou allez sur le site www.dr-schutz.com.

En mettant à disposition ces instructions de nettoyage et d'entretien, le poseur de revêtements de sol a rempli ses obligations conformément à la norme DIN 18365. Vous trouverez les informations les plus récentes relatives au nettoyage et à l'entretien sur www.project-floors.com à la rubrique « Téléchargements ».

7. Informations importantes

Commerces, zones de passage :

Dans les zones très fréquentées, nous conseillons d'appliquer un vitrifiant PU avant la première utilisation.

Salons de coiffure, concessionnaires automobiles :

Pour contrecarrer les décolorations et les migrations du plastifiant, nous conseillons d'utiliser le vitrifiant PU « Anti-Color » résistant aux taches et aux colorants de la société Dr. Schutz.

Secteur de la santé :

Dans tous les endroits où sont utilisés des désinfectants pour les mains et de surfaces, nous recommandons l'emploi du vitrifiant PU. Ceci permet d'assurer au revêtement de sol une protection à long terme optimale et prévient les décolorations éventuelles provoquées par les désinfectants.

Maintien de la valeur :

Les revêtements de sol PROJECT FLOORS peuvent généralement être perfectionnés/ravivés à tout moment avec le vitrifiant PU pour éliminer les traces d'usure mécanique devant laquelle l'entretien quotidien reste impuissant.

Pour une protection supplémentaire contre les rayures et les égratignures dues au déplacement de meubles, nous conseillons l'emploi de patins en feutre. Les chaises de bureau doivent être équipées de roulettes doubles de type W (souples) selon DIN 68131 pour être utilisées sur les revêtements de sol PROJECT FLOORS.

La surface est ensuite passée à la serpillière avec le nettoyeur PU légèrement humide conformément au mode d'emploi. Nous recommandons là aussi l'utilisation de l'ensemble balai vaporisateur Dr. Schutz.



Mehr zum Design!
More about the design!

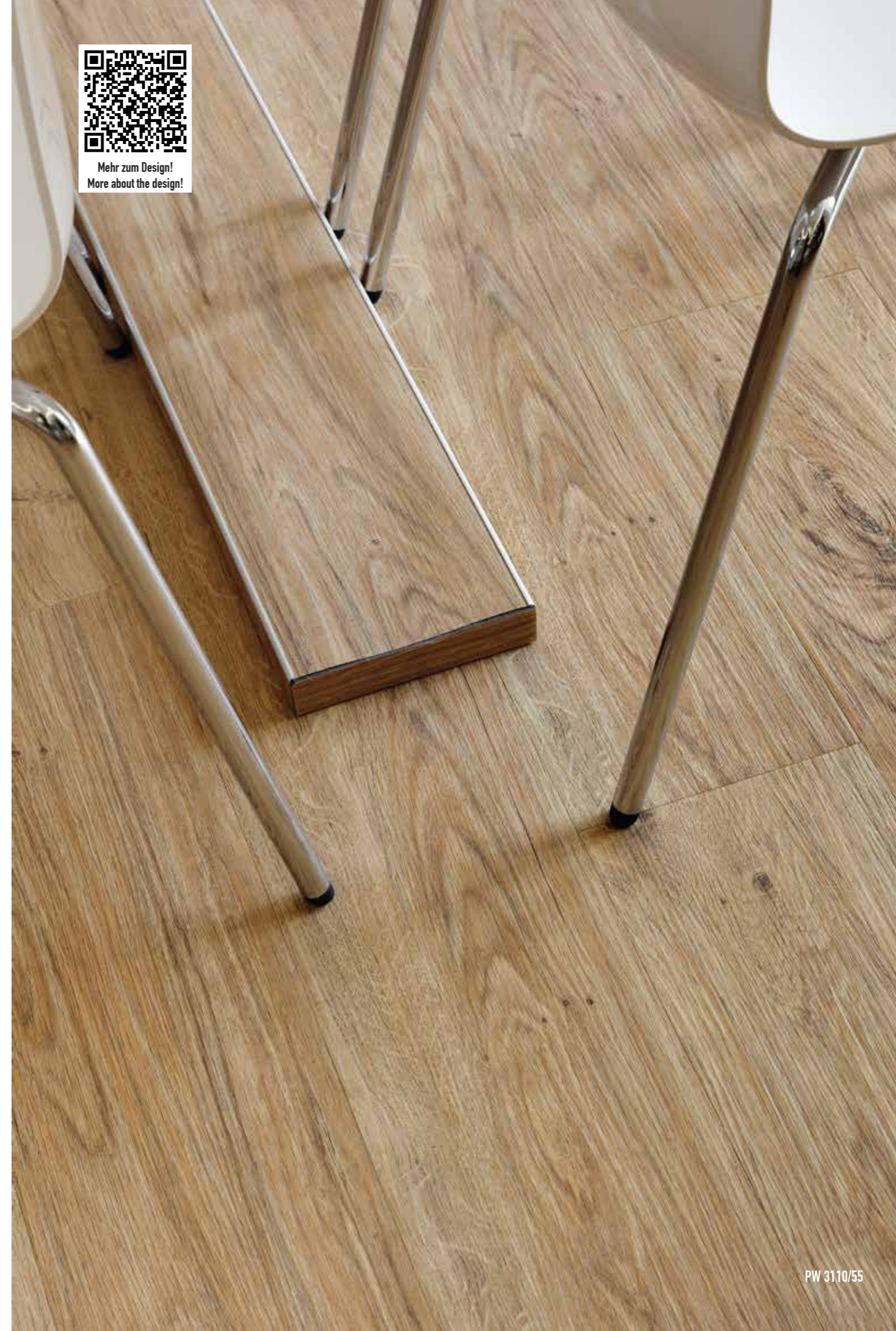

Technische Gegevens	floors@work/55
Vloer volgens EN ISO 10582	Heterogene planken / tegels, type 1
Totale dikte ISO 24346	2,5 mm
Verpakkings eenheid/pallets	3,34 m ² /200,40 m ² 600 x 600 mm: 3,24 m ² /194,40 m ²
Classificering EN ISO 10582 / ISO 10874	23, 33, 42
PU dikte ISO 24340	0,55 mm
Aantal kleuren	60 planken / 27 tegels
Schuine afgewerkte kanten	ja (afhankelijk van het design)
Totaalgewicht ISO 23997	3,81 kg/m ²
Verzegeling	ja / PU
Restindruk ISO 24343-1	≤ 0,1 mm*
Maatvastheid ISO 23999	≤ 0,15 %*
Bestand tegen stoelwielen ISO 4918	ja, gem. EN 12529, type W
Vloerverwarming	geschikt volgens DIN EN 12664
Brandweerstand EN 13501-1	Bfl-s1
Weerstand tot warmte geleidend vermogen ISO 8302 / EN 12667	0,02 m ² K/W
Elektrostatisch gedrag bij het betreden EN 1815	< 2 kV
db waarde ISO 10140-3	4 dB
Kleurvastheid ten opzichte van kunstlicht ISO 105-B02/2	≥ 7
Stroomgeleiding EN 1081	> 10 ¹² Ω
Chemicaliën bestand ISO 26987	ja**
Stroefheidsklasse	R9 tot R10 (afhankelijk van het design)
Reinings- en onderhoudsadvies	Dr. Schutz

* Gemiddelde waarde

** Bij korte inwerking van gebruikelijke huishoudmiddelen.

Legadvies

1. Algemeen

Controleer de geleverde artikelen met het oog op de bestelde hoeveelheid en het juiste decor. Vóór het leggen moet gecontroleerd worden of alle pakketten uit dezelfde charge afkomstig zijn en of er gebreken zijn. Gelijkheid van kleur van de artikelen is alleen te waarborgen bij de levering uit één fabricage (charge). We doen er alles aan alleen artikelen uit dezelfde charge te leveren. Gelieve daarom, bij een eventuele nabestelling voor een bepaald object, altijd het chargennummer aan te geven. Als het op basis van onze voorraad niet lukt een artikel na te leveren uit dezelfde charge, krijgt u artikelen die gelijk zijn aan de eerder aan u geleverde charge. Als de charge afwijkt, brengen we u daarvan op de hoogte. Beschadigde of ontbrekende planken moeten voor het leggen uitgesorteerd worden en o.v.v. het artikel- en fabricagenummer worden gereclameerd. Zichtbare gebreken kunnen na het leggen niet meer worden erkend. Gelieve bij herkenbare gebreken onmiddellijk contact op te nemen met uw leverancier. Voor extra bescherming tegen krassen door meubelstukken die verplaatst kunnen worden, moeten er na het leggen viltglijders worden toegepast („scratchnomore“ van Dr. Schutz).

2. Ondergrond

Geschikt voor alle ondergronden die vlak, schoon, droog, vrij van vet en scheuren zijn en waarvan de oppervlaktetemperatuur van de ondergrond niet minder dan 15°C bedraagt. De nationale richtlijnen en normen zijn van kracht evenals de erkende regels uit het vak. De vloer moet gelegd worden volgens VOB deel C DIN 18365 legwerkzaamheden voor vloeren en de minimum eisen die aan betonvloeren worden gesteld conform DIN 18560. Verder moet DIN 18202, toleranties in de hoogbouw nageleefd worden. Bij verwarmde vloerconstructies moet het informatieblad van het Duitse Zentralverband Sanitär-Heizung-Klima „Schnittstellenkoordinaten bei Fußbodenkonstruktionen“ en het informatieblad van het Duitse Zentralverband Parkett und Fußbodentechnik nageleefd worden. DIN EN1246-4:2001-12 moet worden nageleefd. De oppervlaktetemperatuur mag niet meer dan 18°C zijn. De oppervlaktetemperatuur van de ondergrond moet tijdens het leggen, tot 72 uur na het leggen constant zijn om een goede binding van de lijm te garanderen. Verder moet het BEB informatieblad „Beurteilen und Vorbereiten von Untergründen, Verlegen von elastischen und textilen Belägen“ nageleefd worden.

Als de vloer op een geplamuurd oppervlak wordt gelegd, is het aan te bevelen de ondergrond met behulp van een rakel in combinatie met een stekelwals voor te bereiden/te behandelen. Informatie hierover is direct verkrijgbaar bij de betreffende plamuur- of lijmfabrikant. Het is dringend aan te bevelen de bouwchemische opbouw in het systeem volgens de aanwijzingen van de fabrikant uit te voeren.

Uitgezonderd als ondergrond zijn alle textiele en vochtgevoelige vloeren, pvc-vloeren met geschuimde rug en laminaatvloeren. Over het algemeen zijn serres uitgesloten, evenals ruimtes die bloot kunnen staan aan fel zonlicht of hitte-invloeden (behalve ruimtes die het hele jaar een relatief constante temperatuur van +/- 5 graden Celsius hebben). Van het leggen op elektrische vloerverwarmingssystemen wordt afgeraden, aangezien hier de verwarmingscurve (temperatuurstijging) te snel is. Ondergronden die niet door PROJECT FLOORS zijn uitgevoerd behoeven een speciale vrijgave. Het leggen op niet vrijgegeven ondergronden kan bij reclamaties tot uitsluiting van de aansprakelijkheid leiden. Wielen en rollen op rubberbasis (bijv. autobanden) kunnen bij voortdurend contact met de PROJECT FLOORS producten tot onherstelbare kleurveranderingen leiden.

3. Acclimatisering

Het materiaal voor de vloer moet minstens 48 uur vóór het uitvoeren van de legwerkzaamheden in de betreffende ruimte acclimatiseren. De acclimatisering mag niet op de pallet, maar moet gebeuren in zo klein mogelijke stapels van maximaal 4 tot 5 pakketten, ca. 50 cm van een muur. De pakketten mogen nooit staand worden opgeslagen. De ruimte moet 48 uur voor, tijdens en 72 uur na het leggen, absoluut aan de volgende omgevingsvoorwaarden voldoen: PROJECT FLOORS Dryback designvloeren moeten gelegd worden bij een ruimtetemperatuur van minstens 18°C, een vloertemperatuur van meer dan 15°C en een relatieve luchtvochtigheid van maximaal 75%. Acclimatisering mag niet in direct zonlicht gebeuren.

4. Leggen

Voor een optimale verdeling van de oppervlakken worden de ruimtes gemeten en met behulp van een schietlood ingedeeld. PROJECT FLOORS vloeren moeten met dispersielijm in een nat lijmbed op zuigende ondergronden over het gehele oppervlak worden vastgelijmd. Houd daarvoor rekening met onze actuele lijmaanbevelingen. Vooral bij lokale omstandigheden (bijv. fel zonlicht, verhoogde luchtvochtigheid) is een individuele benadering nodig bij het leggen. Ga naar onze website voor meer informatie of neem contact op met onze afdeling toepassings-techniek. De gegevens van de lijmfabrikant, bijv. met het oog op hoeveelheid, verdampingstijd enz. moeten absoluut aangehouden worden. Bij gebruik van een andere lijm heeft u altijd schriftelijke toestemming van ons en de lijmfabrikant nodig.

5. Bijzonderheden bij visgraat- en chevron-planken

Voor het succesvol en mooi leggen van visgraatplanken in visgraat-, ladder- of chevron-patroon is concentratie en voorbereiding nodig. We geven u een paar aanwijzingen die u bij het uitvoeren van de werkzaamheden van pas kunnen komen:

Bij het leggen in visgraat-motief:

Bij het zetten van de 90° hoek tijdens het leggen, moet erop gelet worden dat de hoek exact 90° meet. Door zelfs een zeer geringe afwijking ontstaan er in de loop van het leggen voegen.

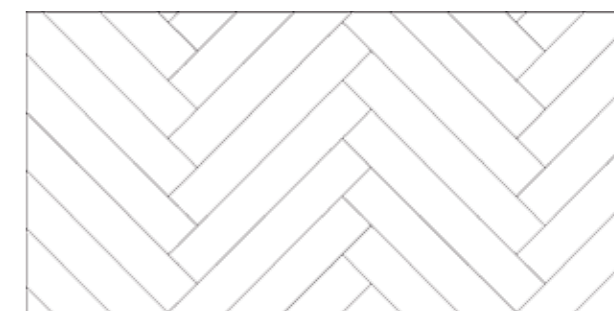

Bij het leggen in chevron-motief:

Bij het leggen van de eerste rij is een roestvrijstalen snijrail of stalen band handig. Hierbij moet erop gelet worden dat de maten precies kloppen. Zelfs de geringste afwijking kan in de loop van het leggen leiden tot voegen.

Verder worden er bij de chevron-collectie 2 verschillende staven gebruikt (linker en rechter staven) die aan de volgende kenmerken te herkennen zijn:

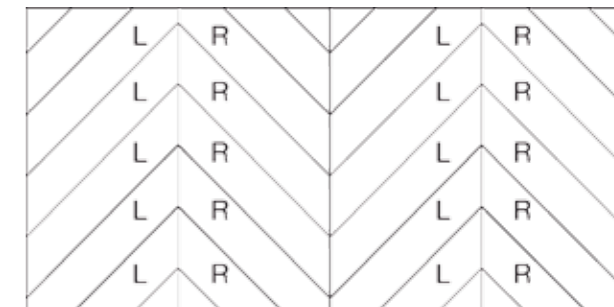

Ze moeten bij het leggen afwisselend van de ene naar de andere zijde worden gelegd.

Onze producten zijn onderhevig aan een strenge kwaliteitscontrole, maar het kan zijn dat de randen iets uitsteken. Deze randen moeten, voor een mooi resultaat, voordat de planken in het lijmbed worden gelegd, verwijderd worden.



Reinigings- en onderhoudshandleiding

1. Algemene informatie

Bij PROJECT FLOORS designvloerbekledingen gaat het over producten, die al voorzien zijn van een fabrieksmatig aangebrachte polyurethaan coating. Om duurzaam een optimaal uitzicht en een lange levensduur te garanderen, is een regelmatige reiniging noodzakelijk. Dit is afhankelijk van de regelmaat van gebruik en het gebied van de toepassing en de keuze van de kleur en het reliëf van het oppervlak van het decor. Een verfijning van de gebruikte laag met behulp van een 2-compo-nenten polyurethaan afdichtingssysteem is op aanvraag mogelijk. In bijzondere situaties van het object is een extra coating zinvol (zie punt 7 "Belangrijke informatie").

2. Preventieve maatregelen

Om het oppervlak tegen mechanische beschadigingen door indringen van vuil water, zand e.a. te beschermen, is het raadzaam om zones met deur-matten aan te leggen. Tijdens de bouwfase is het nodig het oppervlak te beschermen tegen mechanische beschadiging door andere gespecialiseerde werkzaamheden.

3. Reiniging na het aanleggen van de vloer-bekledingen

Na voltooiing van het aanleggen van de vloerbekledingen is een reiniging nodig om aanwezig bouwvuil en lijmresten volledig te verwijderen. Deze is niet hetzelfde als een basisreiniging (zie punt 6).

Volgens de door hersteller voorgeschreven droog-tijd van de lijm, moet het vloeroppervlak met PU-reiniger (niet met basisreiniger), die met water werd verdund (volgens de voorwaarden van de fabrikant), gereinigd worden. Het vuile water moet volledig worden afgevoerd en de vloer moet dan ontsmet worden met veel schoon water. De reiniging na het aanleggen van de vloer-bekledingen dient niet als voorbereidende maat-regel om een initiële behandeling (zie punt 4) uit te voeren! Hiervoor is een basisreiniging (zie punt 6) nodig.

4. Initiële behandeling

Wegens de reeds aanwezige oppervlaktebehandeling is een initiële behandeling niet verplicht. Als de droogtijden van de lijm die in rekening zijn genomen, is het gelegd oppervlak direct beloopbaar.

Naargelang de toepassing en het gebied van toepassing kan, indien gewenst, een hoogwaardig PU-afdichtingssysteem van de fa. Dr. Schutz aan-gebracht worden. Hierbij verkrijgt het vloeroppervlak een extra bescherming tegen de mechanische invloeden van het dagelijks gebruik. Graag geven we ook individueel advies, afgestemd op de toepassing – neem contact met ons op!

5. Huidige reiniging en actueel onderhoud

Onder actueel onderhoud begrijpt men een handmatige reiniging, die wordt uitgevoerd met gebruik van een conventionele dweil. Eerst wordt het grove vuil verwijderd met een borstel of een stofzuiger. Daarna wordt het oppervlak gereinigd met de PU-reiniger volgens de gebruikershandleiding.

6. Basisreiniging

Naargelang de graad van vervuiling kan de vloer over langere perioden met de basisreiniger R (Dr. Schutz), verdund volgens fabrieksspecificaties, gereinigd worden. Na volledige opname van het vuil water wordt de vloerbekleding met schoon, warm water ontsmet, tot alle vuil- en schoonmaakresten volledig verwijderd zijn. Daarna kan indien gewenst een initiële behandeling uitgevoerd worden (zie punt 4). Voor grotere oppervlakken wordt het gebruik van reinigings- en onderhoudsapparatuur aanbevolen.

Als onderhoudsproducten van andere fabrikanten worden gebruikt, moet dit worden overeengekomen met de respectieve fabrikanten van de onderhoudsmiddelen. Indien u nog andere vragen hebt over de juiste reiniging en het juiste onderhoud van vloerbekledingen, raadpleeg dan a.u.b. de dienst voor adviesverlening van Dr. Schutz, Bonn Tel.: +49 228 95352 0, Fax: +49 228 95352 28 of op www.dr-schutz.com.

Door verspreiding van deze reinigings- en onderhoudshandleiding vervult de vloerlegger zijn plicht volgens DIN 18365. De meest recente informatie over reiniging en onderhoud vindt u op www.project-floors.com onder „Downloads“.

7. Belangrijke informatie

Winkels, wandelzones:

In zones met te verwachten hoger regelmatig gebruik bevelen we aan vóór het eerste gebruik een geschikt PU-afdichtingssysteem aan te brengen.

Kapsalons, autodealers:

Het vlek- en kleurstofresistente PU-afdichtings-systeem „Anti-Color“ van de firma Dr. Schutz wordt aanbevolen, om verkleuringen en kleurverloop door weekmakers tegen te werken.

Hygiëne:

overal waar hand- en oppervlakdesinfectiemiddelen worden gebruikt, bevelen we het gebruik van het PU-afdichtingssysteem aan. Hierdoor verkrijgt het oppervlak een optimale langdurige bescherming en wordt de eventuele verkleuring door het desinfectiemiddel verhinderd.

Waardebehoud:

PROJECT FLOORS vloerbekledingen kunnen in het algemeen steeds na aanleg worden veredeld/-opgefrist, indien er sporen van slijtage aanwezig zijn door mechanische belasting, die door middel van dagelijkse zorgen niet meer te herstellen zijn.

Voor extra bescherming tegen kerven en krassen door verplaatsen van meubelstukken, zijn nadien aangebrachte viltglijders voorzien. Bureau-stoelen moeten voor gebruik op PROJECT FLOORS vloerbekledingen met zachte dubbele zwenkwielen, type W (zacht) volgens DIN 68131 uitgerust zijn.



Mehr zum Design!
More about the design!

 Ficha Técnica		floors@work/55
Lujo, alto rendimiento Suelos de PVC para un desgaste alto en el sector comercial y para un máximo desgaste en viviendas.		
Cobertura tipo de conformidad con EN ISO 10582	Lamas Madera / Losetas Heterogéneas, tipo 1	
Grosor Total ISO 24346	2,5 mm	
Caja/Palet	3,34 m ² /200,40 m ² 600 x 600 mm: 3,24 m ² /194,40 m ²	
Clasificación Rendimiento EN ISO 10582 / ISO 10874	23, 33, 42	
Grosor capa de uso ISO 24340	0,55 mm	
Número de colores	60 lamas maderas / 27 losetas	
Bordes biselados	si (depende del diseño)	
Peso Total ISO 23997	3,81 kg/m ²	
Tratamiento superficie	si / PU	
Indentación Residual ISO 24343-1	≤ 0,1 mm*	
Estabilidad de dimensión ISO 23999	≤ 0,15 %*	
Indicado para sillas de ruedas ISO 4918	Apto para sillas de ruedas con EN 12529, tipo W	
Calefacción radiante	adecuado según DIN EN 1264	
Comportamiento al fuego EN 13501-1	Bfl-s1	
Resistencia conductividad térmica ISO 8302 / EN 12667	0,02 m ² K/W	
Comportamiento electrostático en la pisada EN 1815	< 2 k/V	
Mejora impacto sonido ISO 10140-3	4 dB	
Solidez de los colores a la luz artificial ISO 105-B02/2	≥ 7	
Características Electroestáticas EN 1081	> 10 ¹² Ω	
Resistencia química ISO 26987	conforme**	
Resistencia al deslizamiento	R9 hasta R10 (depende del diseño)	
Mantenimiento/Recomendación limpieza	Dr. Schutz	

* Valor medio

** Vis-à-vis los efectos a corto plazo de los agentes normales, nacionales.

Instrucciones de colocación

1. Indicaciones generales

Examine el suministro recibido, comprobando la cantidad suministrada y el acabado deseado. Antes de la colocación, controle todos los paquetes para comprobar que pertenecen al mismo lote y que no presentan defectos. La homogeneidad del color de la mercancía puede garantizarse solamente si procede del mismo lote de producción. Hacemos todo lo posible para suministrar en cada entrega mercancía perteneciente a un mismo lote. Por ese motivo, si desea ampliar un pedido, le rogamos que especifique siempre el número de lote del pedido original. Siempre que nos lo permitan las existencias de almacén, recibirá mercancía del mismo lote que el suministro original. En otro caso, le informaremos de la divergencia. Las tablillas defectuosas o deterioradas deben separarse antes de la colocación, y debe cursarse la reclamación correspondiente con indicación del número de referencia y el lote de producción. Una vez colocados los elementos no se reconocerán defectos visibles. Si se aprecian defectos, póngase inmediatamente en contacto con su proveedor.

Para poder utilizar sillones de escritorio sobre los revestimientos PROJECT FLOORS, es preciso que estén equipados con ruedas blandas de tipo W según la norma DIN 68131. Con el fin de proveer una protección adicional y evitar arañazos y rayones debidos al movimiento de muebles es la colocación de fieltros deslizantes en las patas („scratchnomore“ de Dr. Schutz).

2. Substrato

Se considera idóneo cualquier substrato plano, limpio, seco y exento de grasas y de fisuras. La temperatura superficial del substrato no debe ser inferior a 15 °C. Se consideran vigentes las directivas y normas nacionales, así como las reglas de la técnica generalmente reconocidas. Deben observarse el Reglamento alemán para adjudicación y contratación de obras de construcción VOB – Parte C – DIN 18365 Suelos y pavimentos, así como los requisitos mínimos a los solados especificados en la norma DIN 18560. Asimismo debe cumplirse la norma DIN 18202, tolerancias en la construcción de edificios.

Si se instala el material sobre una calefacción por suelo radiante, es preciso observar las exigencias de la hoja informativa de la Agrupación Central Alemana de instalaciones sanitarias, calefacción y aire acondicionado „Coordenadas de las interfaces en construcciones del suelo“ y la hoja informativa de la Agrupación Central Alemana de Técnica de Parquet y Suelos. Debe cumplirse la norma DIN EN 1246-4:2001-12. La temperatura superficial no debe ser mayor de 18 °C. La temperatura superficial del substrato debe ser constante durante la colocación y durante las 72 horas siguientes con el fin de asegurar un curado adecuado del adhesivo. Por lo demás, debe observarse la hoja informativa de BEB (Agrupación Federal Solados y Pavimentos) „Evaluación y preparativos en substratos, colocación de revestimientos elásticos y textiles“.

Si se desea colocar las tablillas sobre una superficie emplastecida, realizada con anterioridad, se recomienda emplastecer el substrato según el procedimiento de rasqueta en combinación con un rodillo de púas o de aireación. El fabricante de la masilla o el adhesivo le podrá ayudar en este tema. Recomendamos vivamente atenerse a las recomendaciones del fabricante del material para la preparación del substrato con los diferentes componentes.

Como subsuelos, se deberían excluir todo tipo de revestimientos textiles o sensibles a la humedad, suelos de PVC con reverso de espuma y suelos de laminado. Se excluyen como regla general las terrazas acristaladas y zonas que pueden estar sometidas a la acción de la radiación solar o del calor (excepto los locales que mantienen durante el año una temperatura relativamente constante, dentro de un margen de +/- 5 grados centígrados). Debido al calentamiento muy rápido de estos sistemas, no se recomienda colocar este pavimento en suelos con calefacción eléctrica por suelo radiante.

Los substratos no indicados en la descripción de PROJECT FLOORS precisan una autorización especial. En caso de reclamación, la colocación sobre substratos no autorizados puede conducir a una pérdida de los derechos de garantía. Las ruedas y los rodillos a base de caucho (por ejemplo, neumáticos de automóviles) pueden originar cambios de color irreparables si permanecen en contacto permanente con los productos PROJECT FLOORS.

3. Aclimatación

Con el fin de permitir su aclimatación, el material del pavimento debe permanecer en los locales previstos para la instalación al menos 48 horas antes de su colocación. No debe aclimatarse el material almacenado sobre el palet en que se suministra, sino en pilas del menor tamaño posible (como máximo 4-5 paquetes, con una separación de unos 50 cm respecto a las paredes). No almacenar nunca los paquetes en posición vertical.

Es preciso observar los requisitos climáticos siguientes en el local de colocación durante las 48 horas previas, durante la colocación y hasta 72 horas después de la colocación:

Los pavimentos de diseño PROJECT FLOORS Dryback deben colocarse a una temperatura ambiente mínima de 18 °C, una temperatura del suelo superior a los 15 °C y una humedad relativa del aire máxima del 75%. La aclimatación no debe llevarse a cabo bajo la acción de la luz solar directa.

4. Colocación

Con el fin de lograr una distribución ideal del material en el suelo se mide el local y se divide con ayuda de una cuerda tintada. Los pavimentos PROJECT FLOORS se colocan aplicando adhesivo de dispersión en toda la superficie sobre un substrato absorbente según el procedimiento de adhesión sobre lecho húmedo. A la hora de elegir el adhesivo, rogamos tenga en cuenta nuestras recomendaciones. Algunas circunstancias del lugar de colocación, como una radiación solar intensa o una influencia elevada de la humedad, pueden exigir un modo de proceder individual. Encontrará información sobre este punto en nuestra página de Internet, o consultando a nuestro departamento de aplicación. Es imprescindible observar las indicaciones del fabricante del adhesivo, por ejemplo, en cuanto a la cantidad, el tiempo de aireación etc. Si se utiliza un adhesivo diferente es preciso solicitar por escrito nuestra autorización y la autorización del fabricante del adhesivo.

5. Particularidades en la colocación de tablillas en espina de pescado y chevron.

La colocación de tablillas en espina de pescado según el esquema de colocación de espina o chevron requiere un alto grado de atención y preparativos adecuados para lograr resultados satisfactorios. Nos permitimos transmitirle algunas indicaciones que le facilitarán la ejecución del trabajo.

Para la colocación de tablillas en patrón de espina de pescado: Durante la formación de ángulos rectos en la colocación del material es preciso asegurarse de que se observa la cota exacta. La más mínima divergencia conducirá a la aparición de intersticios durante la instalación:

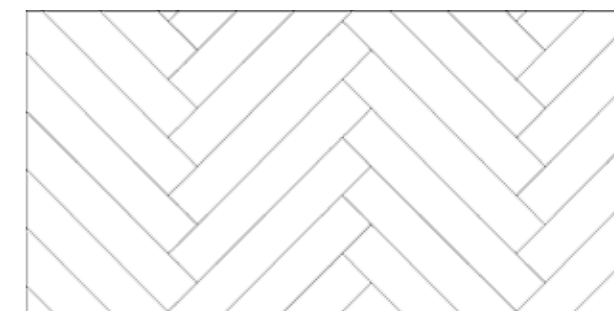

Para la colocación de tablillas en patrón chevron:

Durante la colocación de la primera fila puede servirse como ayuda de una regleta o una banda de acero inoxidable. Es preciso asegurarse de que las dimensiones de este elemento son exactas. La más mínima divergencia conducirá a la aparición de intersticios durante la instalación. Por lo demás, la colección chevron consta de 2 tipos diferentes de tablillas (lado izquierdo y lado derecho), que pueden reconocerse como sigue:

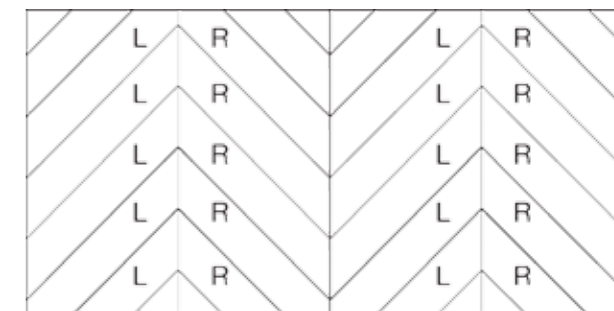

Las tablillas deben colocarse de forma alternada de uno al otro lado.

Nuestros productos se someten a un control estricto de calidad; no obstante, puede ser que se forme un saliente en la zona de los bordes. Estos salientes deben eliminarse antes de colocar la tablilla en el lecho de adhesivo para poder asegurar un apoyo impecable entre las tablillas.



Instrucciones de limpieza y mantenimiento

1. Algemene informatie

Bij PROJECT FLOORS designvloerbekledingen gaat het over producten, die al voorzien zijn van een fabrieksmatig aangebrachte polyurethaan coating. Om duurzaam een optimaal uitzicht en een lange levensduur te garanderen, is een regelmatige reiniging noodzakelijk. Dit is afhankelijk van de regelmaat van gebruik en het gebied van de toepassing en de keuze van de kleur en het reliëf van het oppervlak van het decor. Een verfijning van de gebruikte laag met behulp van een 2-compo-nenten polyurethaan afdichtingssysteem is op aanvraag mogelijk. In bijzondere situaties van het object is een extra coating zinvol (zie punt 7 "Belangrijke informatie").

2. Preventieve maatregelen

Om het oppervlak tegen mechanische beschadigingen door indringen van vuil water, zand e.a. te beschermen, is het raadzaam om zones met deur-matten aan te leggen. Tijdens de bouwfase is het nodig het oppervlak te beschermen tegen mechanische beschadiging door andere gespecialiseerde werkzaamheden.

3. Reiniging na het aanleggen van de vloer-bekledingen

Na voltooiing van het aanleggen van de vloerbekledingen is een reiniging nodig om aanwezig bouwvuil en lijmresten volledig te verwijderen. Deze is niet hetzelfde als een basisreiniging (zie punt 6).

Volgens de door hersteller voorgeschreven droog-tijd van de lijm, moet het vloeroppervlak met PU-reiniger (niet met basisreiniger), die met water werd verdund (volgens de voorwaarden van de fabrikant), gereinigd worden. Het vuile water moet volledig worden afgevoerd en de vloer moet dan ontsmet worden met veel schoon water. De reiniging na het aanleggen van de vloer-bekledingen dient niet als voorbereidende maat-regel om een initiële behandeling (zie punt 4) uit te voeren! Hiervoor is een basisreiniging (zie punt 6) nodig.

4. Initiële behandeling

Wegens de reeds aanwezige oppervlaktebehandeling is een initiële behandeling niet verplicht. Als de droogtijden van de lijm die in rekening zijn genomen, is het gelegd oppervlak direct beloopbaar.

Naargelang de toepassing en het gebied van toepassing kan, indien gewenst, een hoogwaardig PU-afdichtingssysteem van de fa. Dr. Schutz aan-gebracht worden. Hierbij verkrijgt het vloeroppervlak een extra bescherming tegen de mechanische invloeden van het dagelijks gebruik. Graag geven we ook individueel advies, afgestemd op de toepassing – neem contact met ons op!

5. Huidige reiniging en actueel onderhoud

Onder actueel onderhoud begrijpt men een handmatige reiniging, die wordt uitgevoerd met gebruik van een conventionele dweil. Eerst wordt het grove vuil verwijderd met een borstel of een stofzuiger. Daarna wordt het oppervlak gereinigd met de PU-reiniger volgens de gebruikershandleiding.

6. Basisreiniging

Naargelang de graad van vervuiling kan de vloer over langere perioden met de basisreiniger R (Dr. Schutz), verdund volgens fabrieksspecificaties, gereinigd worden. Na volledige opname van het vuil water wordt de vloerbekleding met schoon, warm water ontsmet, tot alle vuil- en schoonmaakresten volledig verwijderd zijn. Daarna kan indien gewenst een initiële behandeling uitgevoerd worden (zie punt 4). Voor grotere oppervlakken wordt het gebruik van reinigings- en onderhoudsapparatuur aanbevolen.

Als onderhoudsproducten van andere fabrikanten worden gebruikt, moet dit worden overeengekomen met de respectieve fabrikanten van de onderhoudsmiddelen. Indien u nog andere vragen hebt over de juiste reiniging en het juiste onderhoud van vloerbekledingen, raadpleeg dan a.u.b. de dienst voor adviesverlening van Dr. Schutz, Bonn Tel.: +49 228 95352 0, Fax: +49 228 95352 28 of op www.dr-schutz.com.

Door verspreiding van deze reinigings- en onderhoudshandleiding vervult de vloerlegger zijn plicht volgens DIN 18365. De meest recente informatie over reiniging en onderhoud vindt u op www.project-floors.com onder „Downloads“.

7. Belangrijke informatie

Winkels, wandelzones:

In zones met te verwachten hoger regelmatig gebruik bevelen we aan vóór het eerste gebruik een geschikt PU-afdichtingssysteem aan te brengen.

Kapsalons, autodealers:

Het vlek- en kleurstofresistente PU-afdichtings-systeem „Anti-Color“ van de firma Dr. Schutz wordt aanbevolen, om verkleuringen en kleurverloop door weekmakers tegen te werken.

Hygiëne:

overal waar hand- en oppervlakdesinfectiemiddelen worden gebruikt, bevelen we het gebruik van het PU-afdichtingssysteem aan. Hierdoor verkrijgt het oppervlak een optimale langdurige bescherming en wordt de eventuele verkleuring door het desinfectiemiddel verhinderd.

Waardebehoud:

PROJECT FLOORS vloerbekledingen kunnen in het algemeen steeds na aanleg worden veredeld/-opgefrist, indien er sporen van slijtage aanwezig zijn door mechanische belasting, die door middel van dagelijkse zorgen niet meer te herstellen zijn.

Voor extra bescherming tegen kerven en krassen door verplaatsen van meubelstukken, zijn nadien aangebrachte viltglijders voorzien. Bureau-stoelen moeten voor gebruik op PROJECT FLOORS vloerbekledingen met zachte dubbele zwenkwielen, type W (zacht) volgens DIN 68131 uitgerust zijn.



Mehr zum Design!
More about the design!

Scheda Tecnica

floors@work/55	
	Rivestimento per pavimenti con design, di alta qualità, in materia plastica per il traffico elevato nelle zone commerciali e la massima sollecitazione negli ambienti domestici.
Superficie in conformità EN ISO 10582	Vinilico Eterogeneo Doghe Legno / Quadrotte
Spessore Totale ISO 24346	2,5 mm
Mq/Confezione/Pallet	3,34 m ² /200,40 m ² 600 x 600 mm: 3,24 m ² /194,40 m ²
Classe d'impiego EN ISO 10582 / ISO 10874	23, 33, 42
Spessore strato d'usura ISO 24340	0,55 mm
Numero di decori	60 doghe legno / 27 quadrotte
Bisellatura	si (in base al decoro)
Peso totale ISO 23997	3,81 kg/m ²
Trattamento superficiale	si / PU
Impronta residua ISO 24343-1	≤ 0,1 mm*
Stabilità dimensionale ISO 23999	≤ 0,15 %*
Idoneo per uso con sedie a rotelle ISO 4918	si – EN 12529, tipo W
Riscaldamento a pavimento	adatto secondo DIN EN 1264
Classificazione Fuoco EN 13501-1	Bfl-s1
Resistenza alla conducibilità ISO 8302 / EN 12667	0,02 m ² K/W
Fenomeni elettrostatici al calpestio EN 1815	< 2 k/V
Miglioramento acustico ISO 10140-3	4 dB
Solidità del colore artificiali ISO 105-B02/2	≥ 7
Caratteristiche elettrostatiche EN 1081	> 10 ¹² Ω
Resistenza ai prodotti chimici ISO 26987	conforme**
Certificazione antisdrucolo	R9 hasta R10 (in base al decoro)
Prodotti per la pulizia raccomandati	Dr. Schutz

* Valore medio

** Resistente ai normali prodotti chimici domestici.

Istruzioni di posa

1. Indicazioni generali

Controllare la merce per verificare che la quantità e il tipo di decorazione oggetto di fornitura corrispondano a quanto effettivamente ordinato. Prima di procedere alla posa, controllare tutti i pacchi per sincerarsi dell'uniformità dei lotti e individuare eventuali difetti. L'omogeneità cromatica della merce è garantita solo nell'ambito del medesimo lotto di produzione. Ci impegniamo a garantire l'omogeneità del prodotto nell'ambito di ciascuna fornitura. In caso di eventuale nuovo ordine per uno stesso immobile, indicare sempre il numero di lotto. Qualora la disponibilità a magazzino lo consenta, ci impegniamo a inviare merce il più possibile uniforme al lotto precedente, in caso contrario si verrà informati delle eventuali variazioni nel lotto. I listelli danneggiati o difettosi vanno scartati prima della posa e segnalati nel reclamo, che dovrà recare il numero di articolo e di confezione. I difetti visibili potrebbero non risultare più riconoscibili dopo la posa. In presenza di difetti evidenti, contattare immediatamente il fornitore.

Ai fini dell'utilizzo sui pavimenti PROJECT FLOORS, le sedie da ufficio devono essere dotate di ruote morbide di tipo W a norma DIN 68131. Per l'ulteriore protezione da segni e graffi dovuti allo spostamento di mobili, utilizzare gli appositi feltrini ("scratchnomore" di Dr. Schutz).

2. Sottofondo

Sono idonei tutti i sottofondi piani, puliti, asciutti, privi di grassi e privi di fessure, con temperatura superficiale non inferiore a 15°C. Si applicano le direttive e norme nazionali, nonché le regole riconosciute di categoria. Osservare la norma VOB Parte C DIN 18365 "Lavori di pavimentazione" e i requisiti minimi previsti per i massetti di cui alla norma DIN 18560. Attenersi altresì alla norma DIN 18202 "Tolleranze nell'edilizia". In caso di pavimenti riscaldati, osservare la nota tecnica della "Associazione centrale tedesca Impianti idraulici, di riscaldamento e di condizionamento dell'aria" intitolata "Coordinamento delle interfacce nei pavimenti" e la nota tecnica della "Associazione centrale tedesca Parquet e tecnica di pavimentazione". Rispettare la norma DIN EN1246-4:2001-12. La temperatura superficiale non deve superare i 18°C.

La temperatura superficiale del sottofondo deve rimanere costante durante la posa e fino alle 72 ore successive, per garantire la corretta presa del collante. Attenersi altresì alla nota tecnica della "Associazione federale tedesca BEB (Massetti e rivestimenti)" dal titolo „Analisi e preparazione di sottofondi, posa di rivestimenti elastici e tessili”.

In caso di posa su una superficie da lavorare a stucco, si consiglia di preparare/stuccare il sottofondo con il metodo della racla abbinata a un

rullo frangibolla o di disaerazione. Per indicazioni in merito, rivolgersi direttamente al produttore dello stucco / delle colle. Consigliamo vivamente di realizzare la completa struttura del sottofondo con prodotti chimici per edilizia di un unico fornitore e in base alle raccomandazioni dello stesso.

Sono esclusi tutti i sottosuoli come rivestimenti tessili e sensibili all'umidità, i rivestimenti in PVC con retro schiumato e i pavimenti laminati. Sono di norma esclusi i giardini d'inverno e le aree potenzialmente esposte a raggi solari o calore di forte intensità (eccetto i locali che presentano tutto l'anno una temperatura relativamente costante di +/- 5°C). È sconsigliata la posa su impianti di riscaldamento a pavimento di tipo elettrico per l'eccessiva rapidità dell'aumento della curva di riscaldamento (aumento della temperatura).

Per i sottofondi non espressamente prodotti da PROJECT FLOORS è necessaria un'approvazione speciale. In caso di reclami, la posa su sottofondi non approvati può comportare l'esclusione dalla garanzia. L'uso di ruote e rotelle in caucciù (ad esempio, pneumatici per auto) può causare modifiche irreparabili del colore in caso di contatto prolungato con i pavimenti delle PROJECT FLOORS prodotti.

3. Acclimatazione

La pavimentazione deve acclimatarsi nei locali d'uso per almeno 48 ore prima della posa. L'acclimatazione non deve avvenire sul bancale, bensì in pile più piccole possibili, di massimo 4-5 pacchi, a una distanza di circa 50 cm dalle pareti. Non stipare mai i pacchi in verticale.

È indispensabile che 48 ore prima della posa, nel corso della lavorazione e nelle 72 ore successive sussistano i seguenti requisiti climatici ambientali: Le condizioni di posa dei pavimenti di design PROJECT FLOORS Dryback prevedono: temperatura dell'ambiente min. 18°C, temperatura del suolo > 15°C e umidità relativa dell'aria max. 75%. L'acclimatazione non deve avvenire in presenza di luce solare diretta.

4. Posa

Per una divisione ottimale della superficie, misurare i locali e suddividerli con una corda battifilo. I pavimenti PROJECT FLOORS vanno incollati sull'intera superficie su sottofondi assorbenti con adesivo in dispersione e procedimento di incollaggio a umido. Attenersi a tale riguardo alle indicazioni aggiornate sugli adesivi consigliati. La presenza di condizioni particolari in loco (per esempio forte irraggiamento, elevato grado di umidità) richiede una procedura di posa specifica. A tale scopo consultare le informazioni presenti sul nostro sito web o rivolgersi al nostro reparto di tecnica applicata. Attenersi scrupolosamente alle indicazioni del produttore dell'adesivo, per esempio in riferimento a quantità, tempo di essiccazione ecc. In caso di utilizzo di un altro tipo di adesivo, è indispensabile l'approvazione scritta da parte nostra e del produttore dell'adesivo.

5. Particolarità per gli elementi posati a spina di pesce e chevron

La posa dei listelli a spina di pesce con il metodo a scaletta o chevron richiede un maggior grado di attenzione e preparazione per ottenere un buon risultato. Di seguito riportiamo alcuni suggerimenti per agevolare le operazioni di posa:

Nella posa a spina di pesce:

Nell'allineamento dell'angolo a 90° in fase di posa, assicurarsi che sia perfettamente a misura. Anche variazioni minime nel corso del procedimento di posa possono dar luogo alla formazione di fughe:



Nella posa in formato chevron:

Nella posa della prima fila è utile usare un binario di guida o una barra d'acciaio. Fare attenzione che sia perfettamente a misura. Anche variazioni minime nel corso del procedimento di posa possono dar luogo alla formazione di fughe.

La collezione Chevron presenta due listelli diversi (destro e sinistro) che si riconoscono come segue:

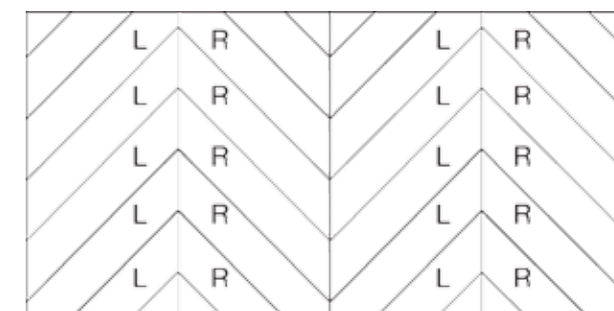

Nella posa essi vanno posati alternati da una parte e dall'altra.

I nostri prodotti sono sottoposti a severi controlli di qualità, tuttavia ai bordi potrebbe essersi formata una sporgenza che va assolutamente eliminata prima di applicare lo strato di adesivo, per assicurare una corretta posa dei listelli.



Istruzioni di cura e pulizia

1. Indicazioni generali

Le pavimentazioni di design PROJECT FLOORS S sono dotate di un rivestimento PU applicato in fabbrica.

Per garantire una perfetta estetica e una lunga durata, è necessario pulire periodicamente la pavimentazione. Gli intervalli di pulizia dipendono dalla frequenza d'uso e dal campo d'impiego, nonché dal colore prescelto e dalla goffatura superficiale della decorazione. È possibile richiedere, volendo, la nobilitazione dello strato di usura mediante un sistema di sigillatura in PU a due componenti. In particolari situazioni può essere opportuno prevedere uno strato di protezione aggiuntivo (vedere il punto 7 "Informazioni importanti").

2. Misure preventive

Per proteggere il pavimento da danni meccanici dovuti a sporco, acqua, sabbia o altro, si consiglia di predisporre idonee zone asciugapassi. Durante i lavori è necessario proteggere il pavimento dai danni meccanici provocati dall'opera di altri artigiani.

3. Pulizia a fine lavori

Al termine della realizzazione del pavimento, è necessario eseguire una pulizia a fine lavori per rimuovere completamente l'eventuale sporco di cantiere e i residui di adesivo presenti. Questa operazione non equivale alla pulizia di base illustrata al punto 6.

Al termine della posa, trascorso il tempo di asciugatura indicato dal produttore dell'adesivo, pulire la pavimentazione con un apposito detergente per PU (non con un detergente di base), diluito con acqua (secondo le indicazioni del produttore). Raccogliere completamente lo sporco e neutralizzare quindi il pavimento con acqua pulita in quantità sufficiente. La pulizia a fine lavori non funge da intervento preparatorio per il trattamento iniziale (vedere il punto 4)! A tale scopo è necessario eseguire una pulizia di base (vedere il punto 6).

4. Trattamento iniziale

Data la presenza della finitura superficiale, non è strettamente necessario eseguire un primo trattamento. A condizione che vengano rispettati i tempi di asciugatura dell'adesivo, la superficie su cui è stato posato il rivestimento può essere subito calpestata.

A seconda del campo d'impiego e della frequenza di calpestio prevista, è possibile eventualmente applicare un sistema di sigillatura in PU di alta qualità della ditta Dr. Schutz. In questo modo, la pavimentazione viene ulteriormente protetta dalle sollecitazioni causate dall'uso quotidiano. Contattateci per ricevere consigli personalizzati a seconda della destinazione d'uso specifica.

5. Pulizia giornaliera e manutenzione

Per pulizia giornaliera si intende la pulizia manuale eseguita con i normali mezzi di pulizia. Rimuovere dapprima lo sporco grossolano con scopa e/o aspirapolvere. Quindi pulire la superficie con il detergente per PU, attenendosi alle istruzioni per l'uso.

Quindi pulire la superficie a umido con il detergente per PU, attenendosi alle istruzioni per l'uso. Anche in questo caso si consiglia di utilizzare il sistema SprayMop di Dr. Schutz.

6. Pulizia di base

A seconda del grado di imbrattamento, il pavimento può essere pulito a intervalli di tempo maggiori con il detergente di base R (Dr. Schutz) diluito come da indicazioni del produttore. Una volta raccolto tutto lo sporco, neutralizzare la superficie con acqua calda pulita fino alla completa eliminazione di tutte le tracce di sporco e detergente. Quindi eseguire, volendo, il trattamento iniziale (vedere il punto 4). Per superfici estese si consiglia l'impiego di apposite macchine di pulizia e manutenzione.

L'impiego di prodotti di pulizia di altri produttori va concordato con il rispettivo produttore. In caso di ulteriori domande sulla corretta pulizia e cura della pavimentazione, rivolgersi al servizio di consulenza di Dr. Schutz, Bonn Tel.: +49 228 95352 0, Fax: +49 228 95352 28 o su www.dr-schutz.com.

Con la consegna delle presenti istruzioni per la cura e la pulizia, il pavimentatore ottempera all'obbligo di cui alla norma DIN 18365. Le informazioni aggiornate sulla cura e la pulizia sono riportate su www.project-floors.com, nell'area "Download".

7. Informazioni importanti

Negozi, aree di passaggio:

In zone a più alto calpestio, si consiglia di applicare, prima del primo utilizzo, un sistema di sigillatura in PU idoneo.

Saloni per parrucchieri, autosaloni:

Si consiglia di applicare il sistema di sigillatura in PU "Anti-Color" di Dr. Schutz, resistente alle macchine e ai coloranti, per contrastare eventuali fenomeni di scolorimento o corrosione.

Sanità:

In tutte le aree in cui si fa uso di disinfettanti per le mani e per le superfici, si consiglia l'impiego del sistema di sigillatura in PU. In questo modo il rivestimento rimane protetto a lungo in modo ottimale e si evita l'eventuale scolorimento dovuto ai disinfettanti.

Mantenimento del valore:

In generale, i rivestimenti PROJECT FLOORS possono essere nobilitati/rinnovati in un secondo momento con il sistema di sigillatura in PU, qualora in seguito a sollecitazioni meccaniche compaiano segni di usura che non possono più essere eliminati mediante la cura quotidiana.

Per l'ulteriore protezione da segni e graffi dovuti allo spostamento di mobili, utilizzare gli appositi feltrini. Ai fini dell'utilizzo sui pavimenti PROJECT FLOORS, le sedie da ufficio devono essere dotate di ruote doppie di tipo W (morbide) a norma DIN 68131.



Mehr zum Design!
More about the design!

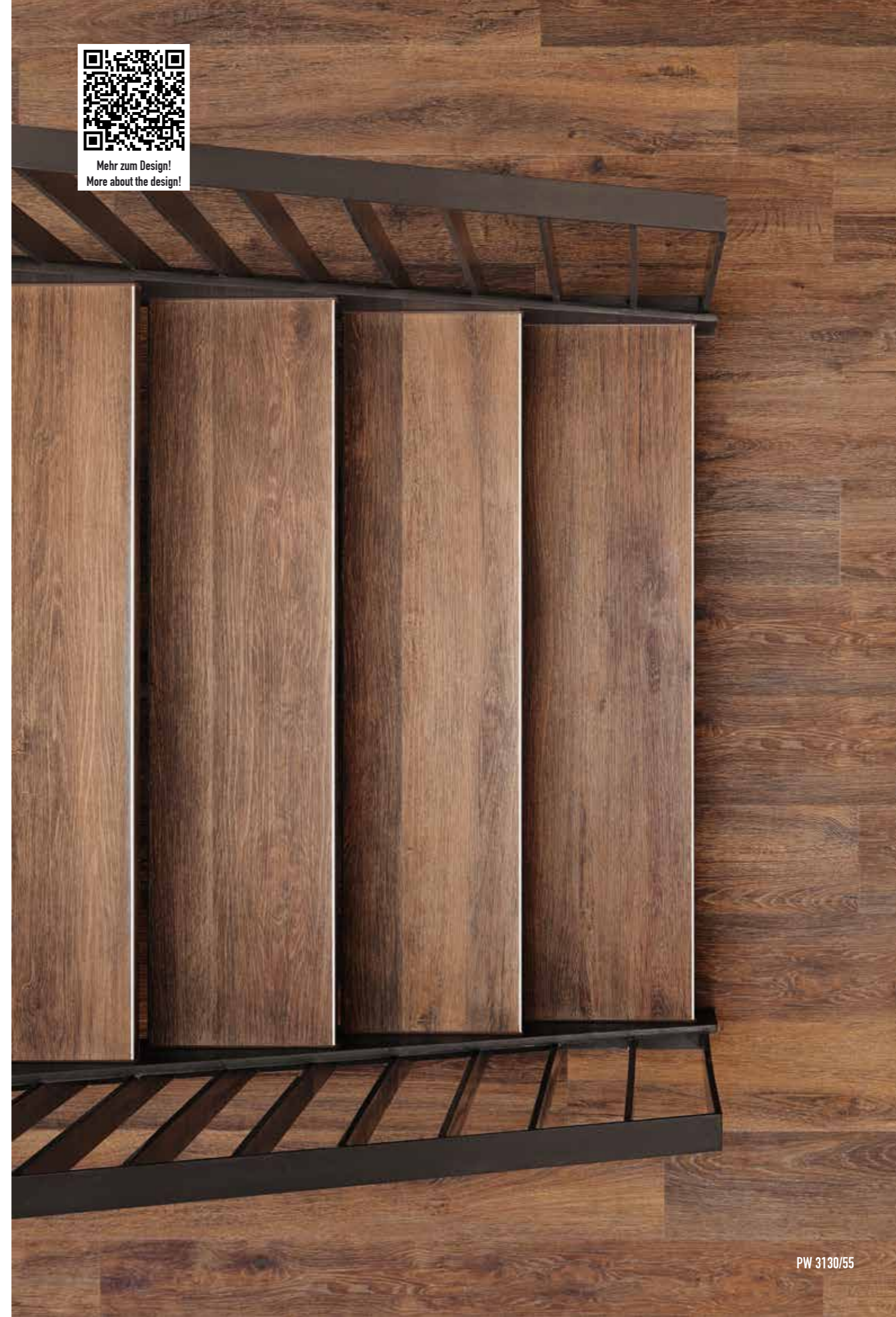



Mehr zum Design!
More about the design!

Durch technische Weiterentwicklung bedingte Änderungen – aktuell nachzulesen unter www.project-floors.com – vorbehalten. Die Muster sind Ausschnitte der jeweiligen Fliesen und Planken und geben somit nur einen kleinen Teil des gesamten Dekors, der Farbe und der Prägung wieder. Selbstverständlich können Sie vor Bestellung Großmuster der von Ihnen ausgesuchten Produkte kostenfrei anfordern.

Bitte beachten Sie, dass Beleuchtung, natürlicher Lichteinfall und Blickwinkel bei Raumbildern einen Einfluss auf die farbliche Darstellung eines Dekors haben können.



Wir bemühen uns selbstverständlich um eine größtmögliche Genauigkeit in der Reproduktion von Farben und Schattierungen in dieser Broschüre.

Subject to change for reasons of further technical development (current changes may be viewed on www.project-floors.com).

The samples are examples of the relevant tiles and planks and thus only reflect a small part of the overall decor, colour and embossing. We advise that you request a large sample of your chosen product free of charge, before ordering the material.

Please note that artificial lighting and change to the incidence of natural light and point of view may have an influence on the design in terms of colour on pictures of residential or commercial applications.

Of course we strive to reproduce colour and tonality with the best possible accuracy in this brochure.

 CE 13
PROJECT FLOORS GmbH Max-Ernst-Str. 4 D 50354 Hürth
EN 14041 - 2004  
Polyvinylchlorid-Bodenbelag gemäß EN 649
NO. DOP-CPR 2000-42506443 floors@work/55 0534
Bodenbelag für die Verwendung in Innenräumen
PROJECT FLOORS ist nach dem Qualitätsmanagementsystem ISO 9001-2015 und der Umweltmanagement-Norm ISO 14001-2015 zertifiziert

Mitglied
Member



Förderkreismitglied
Sponsoring member



Your Project. Our Floors.



2023-01

PROJECT FLOORS GmbH
+49 (0) 2233 9687 - 0
www.project-floors.com
info@project-floors.com

PROJECT
FLOORS